

NZ Amateur Radio Certificate

Block Course Study Notes



www.nzart.org.nz

Teachers Edition

June 2019

Table of Contents

INTRODUCTION.....	4
General Amateur Operator’s Certificate Prescription	5
Amateur Examination Procedure and Format	5
Section 1 – Radio Regulations	6
Radiocommunications Regulations (Extract from -RSM MBIE)	11
Question File: 1. Regulations: (7 questions)	17
Section 2 – Frequencies.....	29
Question File: 2. Frequencies: (2 questions).....	30
Section 3 – Electronics Fundamentals	34
Question File: 3. Electronics Fundamentals: (2 questions).....	36
Section 4 – Measurement	40
Question File: 4. Measurement Units: (1 question)	41
Section 5 – Ohms Law	43
Question File: 5. Ohm's Law: (2 questions).....	44
Section 6 – Resistance.....	48
Question File: 6. Resistance: (3 questions)	51
Section 7 – Power Calculations.....	57
Question File: 7. Power calculations: (2 questions).....	58
Section 8 – Alternating Current	62
Question File: 8. Alternating current: (1 question)	63
Section 9 – Capacitors, Inductors, and Resonance.....	65
Question File: 9. Capacitors, Inductors, Resonance: (2 questions).....	67
Section 10 – Safety.....	71
Question File: 10. Safety: (1 question).....	73
Section 11 – Semiconductors	75
Question File: 11. Semiconductors: (2 questions)	76
Section 12 – Device Recognition	80
Question File: 12. Device recognition: (1 question)	81
Section 13 - Meters and Measuring.....	84
Question File: 13. Meters and Measuring: (1 question).....	85
Section 14 - Decibels.....	87
Question File: 14. Decibels, Amplification and Attenuation: (1 question).....	88
Section 15 Station Components	90
Question File: 15. HF Station Arrangement: (1 question)	92
Section 16 Receiver Block Diagrams.....	96
Question File: 16. Receiver Block Diagrams: (2 questions)	101
Section 17 Receiver fundamentals	106
Question File: 17. Receiver Operation: (3 questions)	108
Section 18 Transmitter Block Diagrams	112
Question File: 18. Transmitter Block Diagrams: (2 questions)	115
Section 19 Transmitter Theory.....	121
Question File: 19. Transmitter Theory: (1 question).....	121
Section 20 Harmonics and Parasitics	123
Question File: 20. Harmonics and Parasitics: (2 questions).....	124
Section 21 Power Supplies.....	128
Question File: 21. Power supplies: (1 question):	133

Section 22 Regulated Power Supplies.....	135
Question File: 22. Regulated Power supplies: (1 question):	137
Section 23 General Operating Procedures	140
Question File 23: General Operating Procedures: (1 Question)	151
Section 24 Operating Procedures and Practice	153
Question File: 24. Practical Operating Knowledge: (2 questions).....	157
Question File 25 Q Codes (1 question)	161
Question File: 25. Q signals: (1 question).....	162
Section 26 Transmission Lines	164
Question File: 26. Transmission lines: (2 questions)	170
Section 27 Antennas.....	174
Question File: 27. Antennas: (4 questions)	179
Section 28 Propagation.....	186
Question File: 28. Propagation: (5 questions)	190
Section 29 Interference and Filtering	198
Question File: 29. Interference & filtering: (3 questions)	212
Section 30 Digital Communications	217
Question File: 30. Digital Systems: (1 question)	221
Creating sample NZART Exam Papers	223

INTRODUCTION

All 600 questions used in the **New Zealand Amateur Radio Examination** are here with the **Syllabus** and other details.

The New Zealand regulatory requirements are explained in the booklet "**The New Rules Explained**", also available from NZART and from the website.

Many overseas books cover the details in the other topics of the Syllabus. Borrow or buy them.

Contact your local NZART Branch when you are ready for the examination. An examination can be arranged for you at a mutually-agreed time and place.

If you have access to a computer, visit the NZART web site at:

<http://www.nzart.org.nz> for examination information including a Study Guide for all parts of the syllabus.

Good luck with your studies, we'll **'see you on the air!'**

Proposed Block Course Timetable

Day 1		Day 2	
0830 - 0900	3 Electronics	0830 - 0900	23 Operating
0900 - 0930	4 Measurement	0900 - 0930	24 Operating 2
0930 - 1000	15 HF Station	0930 - 1000	12 Devices
1000 - 1020	Break	1000 - 1020	Break
1020 - 1100	5 Ohms Law	1020 - 1100	13 Meters
1100 - 1130	7 Power Law	1100 - 1130	26 Transmission Lines
1130 - 1200	10 Safety	1130 - 1200	27 Antennas
1200 - 1230	Lunch	1200 - 1230	Lunch
1230 - 1300	16 Receivers	1230 - 1300	21 PSU
1300 - 1330	17 Receivers 2	1300 - 1330	22 Reg PSU
1330 - 1400	6 Resistance	1330 - 1400	14 dBs
1400 - 1430	8 AC Theory	1400 - 1430	28 Propagation
1430 - 1500	9 Resonance	1430 - 1500	29 Interference
1500 - 1520	Break	1500 - 1520	30 Digi modes
1520 - 1600	18 Transmitters	1520 - 1600	Break
1600 - 1630	19 Transmitters 2	1600 - 1630	Exam
1630 - 1700	20 harmonics	1630 - 1700	Exam
1700 - 1730	11 Semis	1700 - 1730	Exam

Yellow	Maths / Science	Own time	
Cyan	DXer	1	Regulations
Pink	Home Brewer	2	Frequencies
		25	Q Code

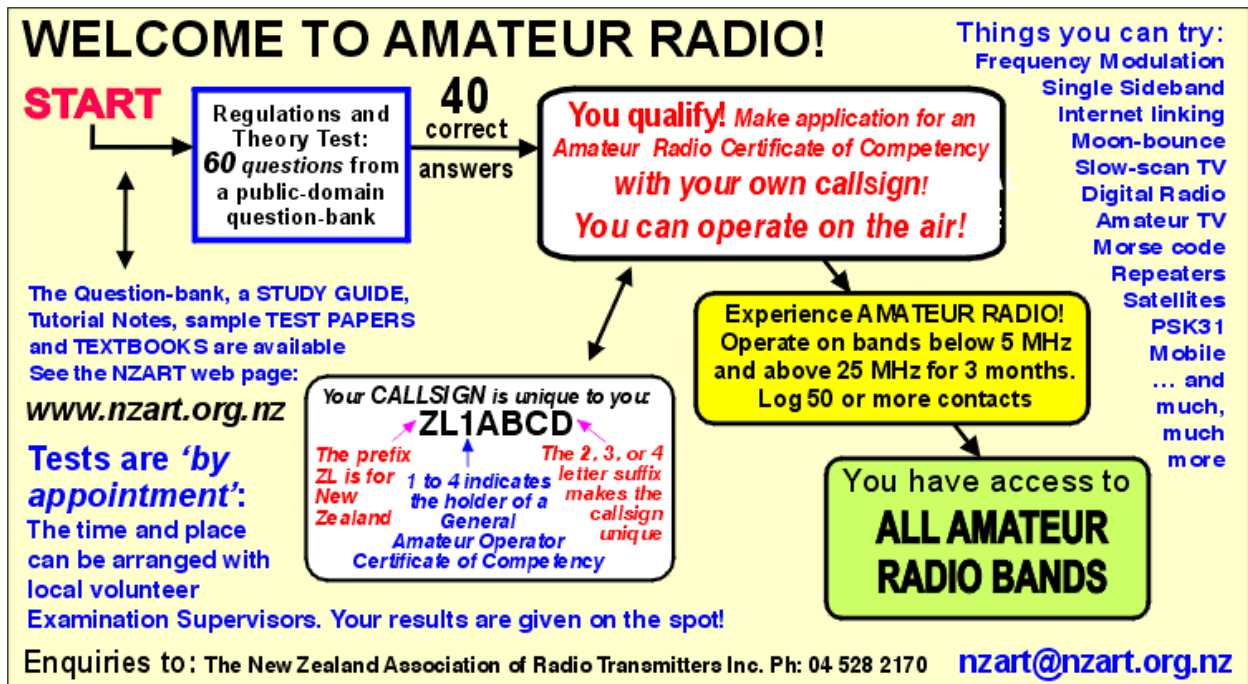

General Amateur Operator's Certificate Prescription

An applicant will demonstrate by way of written examination a theoretical knowledge of:-

- the legal framework of New Zealand radiocommunications
- the methods of radiocommunication, including radiotelephony, radiotelegraphy, data and image
- radio system theory, including theory relating to transmitters, receivers, antennas, propagation and measurements
- electromagnetic radiation
- electromagnetic compatibility
- avoidance and resolution of radio frequency interference.

Amateur Examination Procedure and Format

The examination questions are taken from a question-bank of 600 questions. All questions are in the public domain.

There are thirty study topics. Each contains a multiple of ten questions.

One question out of every ten questions is randomly selected from each topic to make up each examination paper. Each examination paper has 60 questions and is unique.

A description of each topic follows in number sequence. The number of questions which will be selected for each examination paper is shown in brackets.

The total number of questions in each topic is ten times the number to be selected from it.

Section 1 – Radio Regulations

Summary

The Amateur Service may be briefly defined as: a radiocommunication service for the purpose of self-training, intercommunication and technical investigation

The organisation responsible for the International Radio Regulations is the: International Telecommunication Union

New Zealand's views on international radio regulatory matters are coordinated by the: Ministry of Business, Innovation and Employment (MBIE)

For regulatory purposes the world is divided into regions each with different radio spectrum allocations. New Zealand is in: Region 3

The prime document for the administration of the Amateur Service in New Zealand is the: New Zealand Radiocommunications Regulations

The administration of the Amateur Service in New Zealand is by: the Ministry of Business, Innovation and Employment Radio Spectrum Management Group

An Amateur Station is a station: in the Amateur Service

An amateur radio licence can be inspected by an authorised officer from the Ministry of Business Innovation and Employment Development: at any time

The fundamental regulations controlling the Amateur Service are to be found in: the International Radio Regulations from the ITU

You must have an amateur General Amateur Operator's Certificate of Competency and a call-sign to: transmit in bands allocated to the Amateur Service

A New Zealand amateur radio licence allows you to operate: anywhere in New Zealand and in any other country that recognises the licence

Under the General User Radio Licence for Amateur Radio Operators, you may operate transmitters in your station: any number at one time

You must keep the following document at your amateur station: your amateur radio operator's certificate of competency with its attached schedule

An Amateur Station is one which is: licensed by the Ministry of Business, Innovation and Employment to operate on the amateur radio bands

If the licensed operator of an amateur radio station is absent overseas, the home station may be used by: any person with an appropriate amateur radio licence

All amateur stations, regardless of the mode of transmission used, must be equipped with: a reliable means for determining the operating radio frequency

An amateur station may transmit unidentified signals: never, such transmissions are not permitted

You may operate your amateur radio station somewhere in New Zealand away from the location entered on your licence for short periods: whenever you want to

Before operating an amateur station in a motor vehicle, you must: hold a current amateur radio operator's certificate of competency

An applicant for a New Zealand amateur radio operator's certificate of competency must first qualify by meeting the appropriate examination requirements. Application may then be made by: any New Zealand citizen or permanent resident

An amateur radio licensee must have a current New Zealand postal mailing address so the Ministry of Business, Innovation and Employment: can send mail to the licensee

If you transmit from another amateur's station, the person responsible for its proper operation is: you, the operator

Your responsibility as a station licensee is that you must: be responsible for the proper operation of the station in accordance with the Radiocommunications Regulations

An amateur station must have a licensed operator: whenever the station is used for transmitting

A log-book for recording stations worked: is recommended for all amateur radio operators

Unlicensed persons in your family cannot transmit using your amateur station if they are alone with your equipment because they must: be licensed before they are allowed to be operators

Amateur radio repeater frequencies in New Zealand are coordinated by: the NZART Engineering and Licensing Group.

The licensed operator of an amateur radio station may permit anyone to: pass brief messages of a personal nature provided no fees or other considerations are requested or accepted

The minimum age for a person to hold a General Amateur Operator's Certificate of Competency in the Amateur Service is: there is no age limit

If you contact another station and your signal is strong and perfectly readable, you should: reduce your transmitter power output to the minimum needed to maintain contact

The age when an amateur radio operator is required to surrender their General Amateur Operator's Certificate of Competency is: there is no age limit

Peak envelope power (PEP) output is the: average power output at the crest of the modulating cycle

The maximum power output permitted from an amateur station is: specified in the schedule attached to the amateur radio licence

The transmitter power output for amateur stations at all times is: the minimum power necessary to communicate and within the terms of the licence

You identify your amateur station by transmitting your: callsign

2

This callsign could be allocated to an amateur radio operator in New Zealand: (E.G). ZL2HF

The callsign of a New Zealand amateur radio station: is listed in the administration's database

These letters are used for the first letters in New Zealand amateur radio callsigns: ZL

The figures normally used in New Zealand amateur radio callsigns are: a single digit, 1 through 4

Before re-issuing, the Ministry of Business, Innovation and Employment normally keeps a relinquished callsign for: 1 year

The General User Radio Licence for Amateur Radio Operators authorises the use of: amateur radio transmitting apparatus only

New Zealand amateur radio licences are issued by the: Ministry of Business, Innovation and Employment (MBIE)

To replace your lost amateur radio certificate, you must: log on to SMART and download a new copy or request an ARX to do this for you.

Notification of a change of address by an amateur radio operator must be made to the Ministry of Business Innovation and Employment within: 1 Month

You must notify the Ministry of Business, Innovation and Employment of changes to your mailing address: by using your logon and password to access SMART and update your client records. To obtain a logon and password email info@rsm.govt.nz or phone 0508 RSM INFO for more help.

A General Amateur Operator's Certificate of Competency is normally issued for: life

A licence that provides for a given class of radio transmitter to be used without requiring a licence in the owner's own name is known as: a general user radio licence

A licensee of an amateur radio station may permit anyone to: pass brief messages of a personal nature provided no fees or other consideration are requested or accepted

International communications on behalf of third parties may be transmitted by an amateur station only if: such communications have been authorised by the countries concerned

The term "amateur third party communications" refers to: messages to or on behalf of non-licensed people or Organisations

The Morse code signal SOS is sent by a station: in grave and imminent danger and requiring immediate assistance

If you hear distress traffic and are unable to render assistance, you should: maintain watch until you are certain that assistance is forthcoming

The transmission of messages in a secret code by the operator of an amateur station is: not permitted except for control signals by the licensees of remote beacon or repeater stations

Messages from an amateur station in one of the following are expressly forbidden: secret cipher

The term "harmful interference" means: interference which obstructs or repeatedly interrupts radiocommunication services

When interference to the reception of radiocommunications is caused by the operation of an amateur station, the station operator: must immediately comply with any action required by the MBIE to prevent the interference

An amateur radio operator may knowingly interfere with another radio communication or signal: never

After qualifying and gaining an amateur radio licence you are permitted to: first operate for three months on amateur radio bands below 5 MHz and bands above 25 MHz to log fifty or more contacts

Morse code is permitted for use by: any amateur radio operator

As a New Zealand amateur radio operator you may communicate with: other amateur stations world-wide

As a New Zealand amateur radio operator you: may train for and support disaster relief activities

Your amateur radio licence permits you to: establish and operate an earth station in the amateur satellite service

You hear a station using the callsign “VK3XYZ stroke ZL” on your local VHF repeater. This is: the station of an overseas visitor

The abbreviation “HF” refers to the radio spectrum between: 3 MHz and 30 MHz

Bandplans showing the transmission modes for New Zealand amateur radio bands are developed and published for the mutual respect and advantage of all operators: to ensure that your operations do not impose problems on other operators and that their operations do not impact on you

The abbreviation “VHF” refers to the radio spectrum between: 30 MHz and 300 MHz

An amateur radio operator must be able to: verify that transmissions are within an authorised frequency band

An amateur station may be closed down at any time by: a demand from an authorised official of the Ministry of Business Innovation and Employment

An amateur radio licence: does not confer on its holder a monopoly on the use of any frequency or band

A person in distress: may use any means available to attract attention

Radiocommunications Regulations (Extract from -RSM MBIE)
(General User Radio Licence for Amateur Radio Operators) Notice 2016

Pursuant to section 111 of the Radiocommunications Act 1989 and Regulation 9 of the Radiocommunications Regulations 2001, and acting under delegated authority from the chief executive, I give the following notice.

Notice

1. Short title and commencement

(1) This notice is the Radiocommunications Regulations (General User Radio Licence for Amateur Radio Operators) Notice 2016.

(2) This notice comes into force on 5 May 2016.

2. Licence

(1) Licence Name: General User Radio Licence for Amateur Radio Operators.

(2) Licence: A general user radio licence is granted for the transmission of radio waves by amateur radio operators in New Zealand, for the purpose of communications in the amateur radio service in accordance with the applicable terms, conditions and restrictions of this notice.

(3) Commencement date: **5 May 2016.**

(4) Licence internet address: <http://www.rsm.govt.nz/about-rsm/spectrum-policy/gazette/gurl/amateur-radio-operators>

3. Spectrum

Low (MHz)	High (MHz)	Reference Frequency (MHz)	Maximum Power dBW	Remarks
0.13	0.19	0.16	7	Special Conditions 1, 3 and 8
0.472	0.479	0.4755	14	Special Condition 1 and 8
1.8	1.95	1.875	30	Special Condition 1
3.5	3.9	3.7	30	Special Condition 1
7	7.1	7.05	30	Special Conditions 5 and 6
7	7.2	7.1	30	
7.2	7.3	7.25	30	Special Condition 1
10.1	10.15	10.125	30	Special Condition 1
14	14.25	14.125	30	Special Conditions 5 and 6
14	14.35	14.175	30	
18.068	18.168	18.118	30	Special Conditions 5 and 6
21	21.45	21.225	30	Special Conditions 5 and 6
24.89	24.99	24.94	30	Special Conditions 5 and 6

26.95	27.3	27.125	7	Special Conditions 1, 2, 4 and 8
28	29.7	28.85	30	Special Conditions 5 and 6
50	51	50.5	30	
51	54	52.5	30	Special Condition 1
144	146	145	30	Special Conditions 5 and 6
146	148	147	30	Special Condition 1
430	440	435	30	Special Condition 1
433.05	434.79	433.92	30	Special Condition 2
435	438	436.5	30	Special Conditions 5 and 6
915	928	921.5	14	Special Conditions 2, 7 and 8
1240	1300	1270	30	Special Condition 1
1260	1270	1265	30	Special Condition 5
2396	2450	2423	30	Special Condition 2
2400	2450	2425	30	Special Conditions 5 and 6
3300	3410	3355	30	Special Condition 1
3400	3410	3405	30	Special Conditions 5 and 6
5650	5670	5660	30	Special Condition 5
5650	5850	5750	30	Special Condition 2
5830	5850	5840	30	Special Condition 6
10000	10500	10250	30	Special Condition 1
10450	10500	10475	30	Special Conditions 5 and 6
24000	24050	24025	30	Special Conditions 2, 5 and 6
24050	24250	24150	30	Special Conditions 1 and 2
47000	47200	47100	30	Special Conditions 5 and 6
76000	81000	78500	30	Special Conditions 1, 5 and 6
122250	123000	122625	30	Special Conditions 1 and 2
134000	136000	135000	30	
134000	141000	137500	30	Special Conditions 5 and 6
136000	141000	138500	30	Special Condition 1
241000	248000	244500	30	Special Condition 1
241000	250000	245500	30	Special Conditions 5 and 6
244000	246000	245000	30	Special Condition 2
248000	250000	249000	30	
275000	1000000	637500	30	Special Conditions 1 and 3

4. Location

(1) Transmit All New Zealand.
Location:

(2) Receive Location: All New Zealand.

5. Special conditions

1. These frequencies are, or may be, allocated for use by other services. Amateur operators must accept interference from, and must not cause interference to, such other services.
2. These frequencies are designated for industrial, scientific and medical (ISM) purposes. These frequencies may also be allocated to Short Range Device (SRD) services. Amateur operators must accept interference from ISM and SRD services within these frequency ranges.
3. Allocated to the amateur service on a temporary basis until further notice.
4. Use is limited to telemetry or telecommand.
5. These frequencies may also be used for amateur satellite communications in the earth-to-space direction.
6. These frequencies may also be used for amateur satellite communications in the space-to-earth direction.
7. Amateur operators must ensure that unwanted emissions from 800 – 915 MHz must not exceed -79 dBW (-49 dBm e.i.r.p.). The reference bandwidth for emissions is 100 kHz.
8. The maximum power is the radiated power in dBW e.i.r.p.

6. General conditions applying to all transmissions under this licence

1. The use of callsigns, including temporary and club callsigns, must be in accordance with publication PIB 46 “Radio Operator Certificate and Callsign Rules” published at www.rsm.govt.nz.
2. Callsigns must be transmitted at least once every 15 minutes during communications.
3. National and international communication is permitted only between amateur stations, and is limited to matters of a personal nature, or for the purpose of self-training, intercommunication and radio technology investigation, solely with a personal aim and without pecuniary interest. The passing of brief messages of a personal nature on behalf of other persons is also permitted, provided no fees or other consideration is requested or accepted.
4. Communications must not be encoded for the purpose of obscuring their meaning, except for control signals by the operators of remotely controlled amateur stations.
5. Amateur stations must, as far as is compatible with practical considerations, comply with the latest ITU-R recommendations to the extent applicable to the amateur service.
6. In accordance with Article 25 of the International Radio Regulations, amateur operators are encouraged to prepare for, and meet, communication needs in support of disaster relief.
7. Amateur beacons, repeaters and fixed links may not be established pursuant to this licence.
8. Unwanted emissions outside the frequency bands specified in this Schedule must comply with the requirements of technical standard ETSI ETS 300 684 published by the European Telecommunications Standards Institute (ETSI).
9. The frequency ranges, maximum power of transmissions within those frequencies ranges, and designated uses of frequencies are those prescribed in this licence. All transmissions in a given frequency range must comply with any special conditions relating to that frequency range.

10. Should interference occur to services licensed pursuant to a radio licence or a spectrum licence, the chief executive reserves the right to require and ensure that any transmission pursuant to this licence changes frequency, reduces power, or ceases operation.
11. Except as provided to the contrary in this notice, maximum power in dBW is the peak envelope power (PX) of the radio transmitter, as defined in the International Radio Regulations Article 1, No. 1.157.

7. Terms, conditions and restrictions applying to New Zealand amateur operators

1. Persons who hold a General Amateur Operator's Certificate of Competency and a callsign issued pursuant to the Regulations may operate an amateur radio station in New Zealand.
2. The callsign prefix of "ZL" may be substituted with the prefix "ZM" by the callsign holder for the period of, and participation in, a recognised contest, or as the control station for special event communications.
3. Operation on amateur bands between 5 MHz and 25 MHz is not permitted unless a person has held a General Amateur Operators Certificate of Competency for three months and logged 50 contacts during this period. The person must keep the logbook record for at least one year and, during this period, produce it at the request of the chief executive.

8. Terms, conditions and restrictions applying to visiting amateur operators

1. Persons visiting New Zealand who hold a current amateur certificate of competency, authorisation or licence issued by another administration, may operate an amateur station in New Zealand for a period not exceeding 90 days, provided the certificate, authorisation or licence meets the requirements of Recommendation ITU-R M.1544 or CEPT T/R 61-01 or CEPT T/R 61-02 and is produced at the request of the chief executive.
2. The visiting overseas operator must use the national callsign allocated by the other administration to the operator, in conjunction with the prefix or suffix "ZL", except where subsection (3) applies, which is to be separated from the national callsign by the character "/" (telegraphy), or the word "stroke" (telephony).
3. The visiting overseas operator may use the prefix or suffix:
 - a. ZL7 when visiting the Chatham Islands
 - b. ZL8 when visiting the Kermadec Islands
 - c. ZL9 when visiting the Sub-Antarctic Islands

9. Consequential revocation of licence

(1) The Radiocommunications (General User Radio Licence for Amateur Radio Operators) Notice 2013, dated 30 July 2013 and published in the *New Zealand Gazette*, 1 August 2013, No. 97, page 2588, is revoked.

(2) Notwithstanding the revocation of the notice under subsection (1), every transmitter capable of making transmissions compliant with the requirements of that notice on the commencement date of this notice is deemed to be compliant with the requirements of this notice.

Dated at Wellington this 3rd day of May 2016.

SIEGMUND JAMES WIESER, Acting Manager, Radio Spectrum Management
Licensing, Ministry of Business, Innovation, and Employment.

Explanatory note

This note is not part of the notice, but is intended to indicate its general effect.

- a. This notice replaces the Radiocommunications Regulations (General User Radio Licence for Amateur Radio Operators) Notice 2013. The principal change from that notice is the addition of 50 – 51 MHz for amateur use following the switch off of analogue VHF TV at these frequencies.
- b. This notice expands the provision in the frequency range 915 – 928 MHz (previously 921 – 928 MHz) at maximum power up to 14 dBW (e.i.r.p.). This provision is also subject to specific unwanted emission limits as specified under Condition 7.

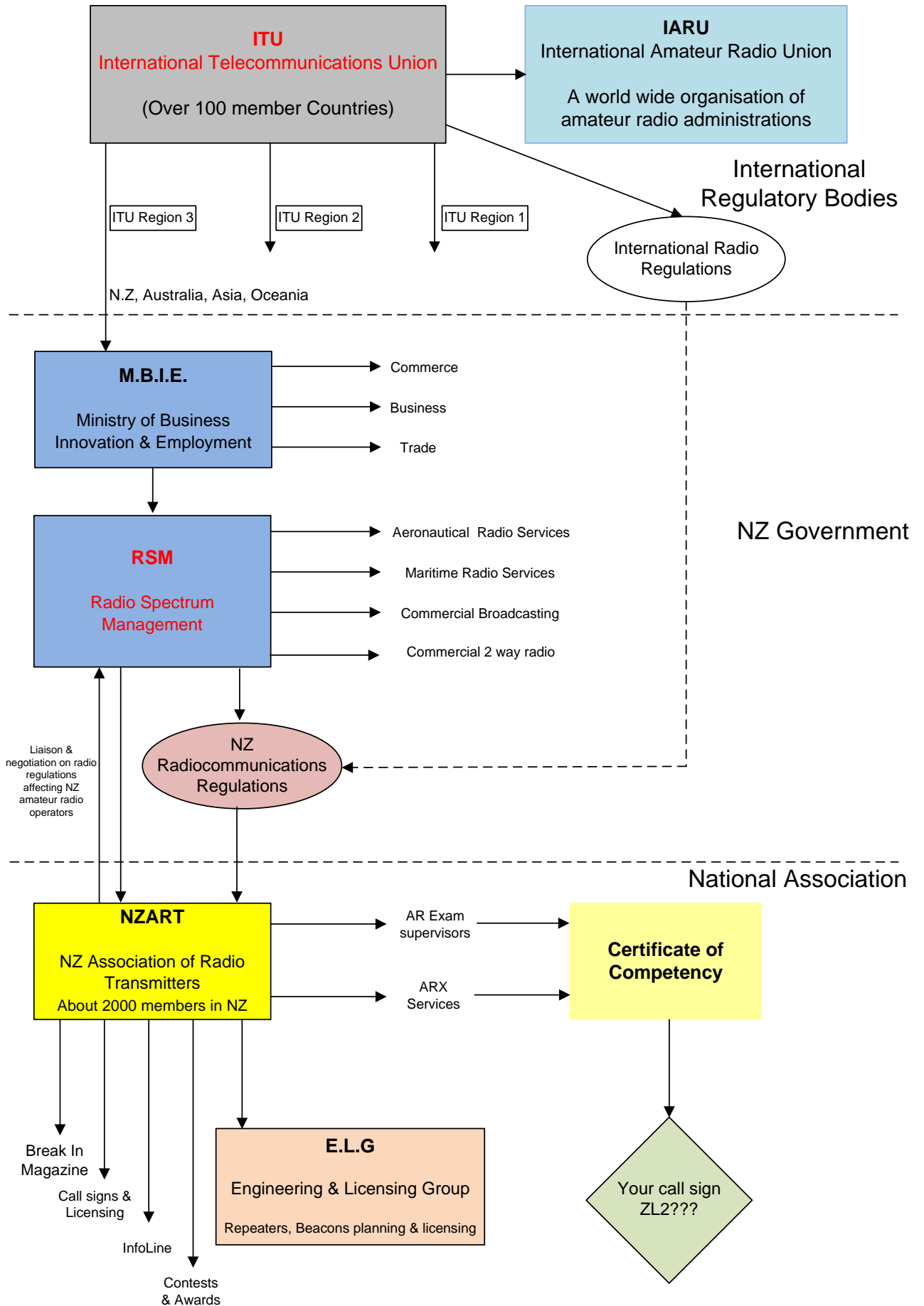

Question File: 1. Regulations: (7 questions)

1. The Amateur Service may be briefly defined as:
 - a. a private radio service for personal gain and public benefit
 - b. a public radio service used for public service communications
 - c. a radiocommunication service for the purpose of self-training, intercommunication and technical investigation
 - d. a private radio service intended only for emergency communications

=====
2. The organisation responsible for the International Radio Regulations is the:
 - a. European Radiocommunications Office
 - b. United Nations
 - c. International Telecommunication Union
 - d. European Telecommunication Standards Institute

=====
3. New Zealand's views on international radio regulatory matters are coordinated by the:
 - a. New Zealand Association of Radio Transmitters (NZART)
 - b. Ministry of Business, Innovation and Employment (MBIE)
 - c. International Amateur Radio Union (IARU)
 - d. Prime Minister's Office

=====
4. For regulatory purposes the world is divided into regions each with different radio spectrum allocations. New Zealand is in:
 - a. Region 1
 - b. Region 2
 - c. Region 3
 - d. Region 4

=====
5. The prime document for the administration of the Amateur Service in New Zealand is the:
 - a. New Zealand Radiocommunications Regulations
 - b. Broadcasting Act
 - c. Radio Amateur's Handbook
 - d. minutes of the International Telecommunication Union meetings

=====
6. The administration of the Amateur Service in New Zealand is by:
 - a. the Ministry of Business, Innovation and Employment Radio Spectrum Management Group
 - b. the Area Code administrators of New Zealand Post
 - c. the Radio Communications Division of the Ministry of Police
 - d. your local council public relations section

=====
7. An Amateur Station is a station:
 - a. in the public radio service
 - b. using radiocommunications for a commercial purpose
 - c. using equipment for training new radiocommunications operators
 - d. in the Amateur Service

- =====
8. A General Amateur Operator Certificate of Competency can be inspected by an authorised officer from the Ministry of Business Innovation and Employment:
- at any time
 - on any business day
 - before 9 p.m.
 - only on public holidays
- =====
9. The fundamental regulations controlling the Amateur Service are to be found in:
- the International Radio Regulations from the ITU
 - the Radio Amateur's Handbook
 - the NZART Callbook
 - on the packet radio bulletin-board
- =====
10. You must have a General Amateur Operator Certificate of Competency to:
- transmit on public-service frequencies
 - retransmit shortwave broadcasts
 - repair radio equipment
 - transmit in bands allocated to the Amateur Service
- =====
11. A New Zealand General Amateur Operator's Certificate of Competency allows you to operate:
- anywhere in the world
 - anywhere in New Zealand and in any other country that recognises the Certificate
 - within 50 km of your home station location
 - only at your home address
- =====
12. With a General Amateur Operator Certificate of Competency you may operate transmitters in your station:
- one at a time
 - one at a time, except for emergency communications
 - any number at one time
 - any number, so long as they are transmitting on different bands
- =====
13. You must keep the following document at your amateur station:
- your General Amateur Operator Certificate of Competency
 - a copy of the Rules and Regulations for the Amateur Service
 - a copy of the Radio Amateur's Handbook for instant reference
 - a chart showing the amateur radio bands
- =====

14. An Amateur Station is one which is:
- a. operated by the holder of a General Amateur Operator's Certificate of Competency on the amateur radio bands
 - b. owned and operated by a person who is not engaged professionally in radio communications
 - c. used exclusively to provide two-way communication in connection with activities of amateur sporting organisations
 - d. used primarily for emergency communications during floods, earthquakes and similar disasters.

- =====
15. If the qualified operator of an amateur radio station is absent overseas, the home station may be used by:
- a. any member of the immediate family to maintain contact with only the qualified operator
 - b. any person with an appropriate General Amateur Operator Certificate of Competency
 - c. the immediate family to communicate with any amateur radio operator
 - d. the immediate family if a separate callsign for mobile use has been obtained by the absent operator

- =====
16. All amateur stations, regardless of the mode of transmission used, must be equipped with:
- a. a reliable means for determining the operating radio frequency
 - b. a dummy antenna
 - c. an overmodulation indicating device
 - d. a dc power meter

- =====
17. An amateur station may transmit unidentified signals:
- a. when making a brief test not intended for reception by anyone else
 - b. when conducted on a clear frequency when no interference will be caused
 - c. when the meaning of transmitted information must be obscured to preserve secrecy
 - d. never, such transmissions are not permitted

- =====
18. You may operate your amateur radio station somewhere in New Zealand for short periods away from the location entered in the administration's database:
- a. only during times of emergency
 - b. only after giving proper notice to the Ministry of Business, Innovation and Employment
 - c. during an approved emergency practice
 - d. whenever you want to
- =====

19. Before operating an amateur station in a motor vehicle, you must:
- give the Land Transport Authority the vehicle's licence plate number
 - inform the Ministry of Business Innovation and Employment
 - hold a current General Amateur Operator Certificate of Competency
 - obtain an additional callsign
- =====
20. An applicant for a New Zealand General Amateur Operator's Certificate of Competency must first qualify by meeting the appropriate examination requirements. Application may then be made by:
- anyone except a representative of a foreign government
 - only a citizen or permanent resident of New Zealand
 - anyone except an employee of the Ministry of Business Innovation and Employment
 - anyone
- =====
21. An amateur radio operator must have current New Zealand postal and email addresses so the Ministry of Business Innovation and Employment:
- has a record of the location of each amateur station
 - can refund overpaid fees
 - can publish a callsign directory
 - can send mail to the operator
- =====
22. If you transmit from another amateur's station, the person responsible for its proper operation is:
- both of you
 - the other amateur (the station's owner)
 - you, the operator
 - the station owner, unless the station records show that you were the operator at the time
- =====
23. Your responsibility as a station operator is that you must:
- allow another amateur to operate your station upon request
 - be present whenever the station is operated
 - be responsible for the proper operation of the station in accordance with the Radiocommunications Regulations
 - notify the Ministry of Business, Innovation and Employment if another amateur acts as the operator
- =====
24. An amateur station must have a qualified operator:
- only when training another amateur
 - whenever the station receiver is operated
 - whenever the station is used for transmitting
 - when transmitting and receiving
- =====

25. A log-book for recording stations worked:
- is compulsory for every amateur radio operator
 - is recommended for all amateur radio operators
 - must list all messages sent
 - must record time in UTC
- =====
26. Unqualified persons in your family cannot transmit using your amateur station if they are alone with your equipment because they must:
- not use your equipment without your permission
 - hold a General Amateur Operator's Certificate of Competency before they are allowed to be operators
 - first know how to use the right abbreviations and Q signals
 - first know the right frequencies and emissions for transmitting
- =====
27. Amateur radio repeater equipment and frequencies in New Zealand are co-ordinated by:
- the Ministry of Business, Innovation and Employment
 - NZART branches in the main cities
 - repeater trustees
 - the NZART Engineering and Licensing Group.
- =====
28. A qualified operator of an amateur radio station may permit anyone to:
- operate the station under direct supervision
 - send business traffic to any other station.
 - pass brief comments of a personal nature provided no fees or other considerations are requested or accepted
 - use the station for Morse sending practice
- =====
29. The minimum age for a person to hold a General Amateur Operator Certificate of Competency is:
- 12 years
 - 16 years
 - 21 years
 - there is no age limit
- =====
30. Which of the following operating arrangements allows a NZ citizen holding a General Amateur Operator's Certificate of Competency and a call-sign to operate in many European countries,
- CEPT agreement
 - IARP agreement
 - ITU reciprocal license
 - All of these choices are correct
- =====

31. The age when an amateur radio operator is required to surrender the General Amateur Operator's Certificate of Competency is:
- 65 years
 - 70 years
 - 75 years
 - there is no age limit
- =====
32. Peak envelope power (PEP) output is the:
- average power output at the crest of the modulating cycle
 - total power contained in each sideband
 - carrier power output
 - transmitter power output on key-up condition
- =====
33. The maximum power output permitted from an amateur station is:
- that needed to overcome interference from other stations
 - 30 watt PEP
 - specified in the amateur radio General User Radio Licence
 - 1000 watt mean power or 2000 watt PEP
- =====
34. The transmitter power output for amateur stations at all times is:
- 25 watt PEP minimum output
 - that needed to overcome interference from other stations
 - 1000 watt PEP maximum
 - the minimum power necessary to communicate and within the terms of the amateur radio GURL
- =====
35. You identify your amateur station by transmitting your:
- "handle"
 - callsign
 - first name and your location
 - full name
- =====
36. This callsign could be allocated to an amateur radio operator in New Zealand:
- ZK-CKF
 - ZLC5
 - ZL2HF
 - ZMX4432
- =====
37. The callsign of a New Zealand amateur radio station:
- is listed in the administration's database
 - can be any sequence of characters made-up by the operator
 - can never be changed
 - is changed annually
- =====

38. These letters are generally used for the first letters in New Zealand amateur radio callsigns:
- ZS
 - ZL
 - VK
 - LZ
- =====
39. The figures normally used in New Zealand amateur radio callsigns are:
- any two-digit number, 45 through 99
 - any two-digit number, 22 through 44
 - a single digit, 5 through 9
 - a single digit, 1 through 4
- =====
40. Before re-issuing, a relinquished callsign is normally kept for:
- 1 year
 - 2 years
 - 0 years
 - 5 years
- =====
41. A General Amateur Operator's Certificate of Competency authorises the use of:
- all amateur radio transmitting and receiving apparatus
 - a TV receiver
 - amateur radio transmitting apparatus only
 - marine mobile equipment
- =====
42. General Amateur Operator's Certificates of Competency and callsigns are issued pursuant to the Regulations by the:
- New Zealand Association of Radio Transmitters (NZART)
 - Ministry of Business, Innovation and Employment Approved Radio Examiners
 - Department of Internal Affairs
 - Prime Minister's Office
- =====
43. To replace a written copy of your General Amateur Operator Certificate of Competency you should:
- Apply to an Approved Radio Examiner to re-sit the examination
 - Download an application form from the Department of Internal Affairs website
 - Download an application form from the Ministry's website (or have an Approved Radio Examiner do this for you)
 - Download and print one from the official database (or have an Approved Radio Examiner do this for you)
- =====

44. A General Amateur Operator's Certificate of Competency holder must advise permanent changes to postal and email addresses and update the official database records within:
- a. one calendar month
 - b. 7 days
 - c. 10 days
 - d. one year
- =====
45. A General Amateur Operator's Certificate of Competency:
- a. expires after 6 months
 - b. contains the unique callsign(s) to be used by that operator
 - c. is transferable
 - d. permits the transmission of radio waves
- =====
46. A General Amateur Operator Certificate of Competency is normally issued for:
- a. 1 year
 - b. 5 years
 - c. 10 years
 - d. life
- =====
47. A licence that provides for a given class of radio transmitter to be used without requiring a licence in the owner's own name is known as:
- a. a repeater licence
 - b. a general user radio licence
 - c. a beacon licence
 - d. a reciprocal licence
- =====
48. The holder of a General Amateur Operator's Certificate of Competency may permit anyone to:
- a. use an amateur radio station to communicate with other radio amateurs
 - b. pass brief messages of a personal nature provided no fees or other consideration are requested or accepted
 - c. operate the amateur station under the supervision and in the presence of a qualified operator
 - d. take part in communications only if prior written permission is received from the Ministry of Business Innovation and Employment
- =====
49. International communications on behalf of third parties may be transmitted by an amateur station only if:
- a. prior remuneration has been received
 - b. such communications have been authorised by the countries concerned
 - c. the communication is transmitted in secret code
 - d. English is used to identify the station at the end of each transmission
- =====

50. The term "amateur third party communications" refers to:
- a simultaneous communication between three operators
 - the transmission of commercial or secret messages
 - messages to or on behalf of non-licensed people or organisations
 - none of the above
- =====
51. The Morse code signal SOS is sent by a station:
- with an urgent message
 - in grave and imminent danger and requiring immediate assistance
 - making a report about a shipping hazard
 - sending important weather information
- =====
52. If you hear distress traffic and are unable to render assistance, you should:
- maintain watch until you are certain that assistance is forthcoming
 - enter the details in the log book and take no further action
 - take no action
 - tell all other stations to cease transmitting
- =====
53. The transmission of messages in a secret code by the operator of an amateur station is:
- permitted when communications are transmitted on behalf of a government agency
 - permitted when communications are transmitted on behalf of third parties
 - permitted during amateur radio contests
 - not permitted except for control signals by the licensees of remote beacon or repeater stations
- =====
54. Messages from an amateur station in one of the following are expressly forbidden:
- ASCII
 - International No. 2 code
 - Baudot code
 - secret cipher
- =====
55. The term "harmful interference" means:
- interference which obstructs or repeatedly interrupts radiocommunication services
 - an antenna system which accidentally falls on to a neighbour's property
 - a receiver with the audio volume unacceptably loud
 - interference caused by a station of a secondary service
- =====

56. When interference to the reception of radiocommunications is caused by the operation of an amateur station, the station operator:
- must immediately comply with any action required by the MBIE to prevent the interference
 - may continue to operate with steps taken to reduce the interference when the station operator can afford it
 - may continue to operate without restrictions
 - is not obligated to take any action

- =====
57. An amateur radio operator may knowingly interfere with another radio communication or signal:
- when the operator of another station is acting in an illegal manner
 - when another station begins transmitting on a frequency you already occupy
 - never
 - when the interference is unavoidable because of crowded band conditions

- =====
58. After qualifying and gaining a General Amateur Operator's Certificate of Competency you are permitted to:
- operate on any frequency in the entire radio spectrum
 - first operate for three months on amateur radio bands below 5 MHz and bands above 25 MHz to log fifty or more contacts
 - ignore published bandplans
 - make frequent tune-up transmissions at 10 MHz

- =====
59. Morse code is permitted for use by:
- only operators who have passed a Morse code test
 - those stations with computers to decode it
 - any amateur radio operator
 - only those stations equipped for headphone reception

- =====
60. As a New Zealand amateur radio operator you may communicate with:
- only amateur stations within New Zealand
 - only stations running more than 500w PEP output
 - only stations using the same transmission mode
 - other amateur stations world-wide

- =====
61. As a New Zealand amateur radio operator you:
- must regularly operate using dry batteries
 - should use shortened antennas
 - may train for and support disaster relief activities
 - must always have solar-powered equipment in reserve
- =====

62. Your General Amateur Operator's Certificate of Competency permits you to:
- work citizen band stations
 - establish and operate an earth station in the amateur satellite service
 - service commercial radio equipment over 1 kW output
 - re-wire fixed household electrical supply mains
- =====
63. You hear a station using the callsign "VK3XYZ stroke ZL" on your local VHF repeater. This is:
- a callsign not authorised for use in New Zealand
 - a confused illegal operator
 - the station of an overseas visitor
 - probably an unlicensed person using stolen equipment
- =====
64. The abbreviation "HF" refers to the radio spectrum between:
- 2 MHz and 10 MHz
 - 3 MHz and 30 MHz
 - 20 MHz and 200 MHz
 - 30 MHz and 300 MHz
- =====
65. Bandplans showing the transmission modes for New Zealand amateur radio bands are developed and published for the mutual respect and advantage of all operators:
- to ensure that your operations do not impose problems on other operators and that their operations do not impact on you
 - to keep experimental developments contained
 - to reduce the number of modes in any one band
 - to keep overseas stations separate from local stations
- =====
66. The abbreviation "VHF" refers to the radio spectrum between:
- 2 MHz and 10 MHz
 - 3 MHz and 30 MHz
 - 30 MHz and 300 MHz
 - 200 MHz and 2000 MHz
- =====
67. An amateur radio operator must be able to:
- converse in the languages shown on the Certificate of Competency
 - read Morse code at 12 words-per-minute
 - monitor standard frequency transmissions
 - verify that transmissions are within an authorised frequency band
- =====
68. An amateur station may be closed down at any time by:
- a demand from an irate neighbour experiencing television interference
 - a demand from an authorised official of the Ministry of Business, Innovation and Employment
 - an official from your local council
 - anyone until your aerials are made less unsightly
- =====

69. A General Amateur Operator's Certificate of Competency:
- a. can never be revoked
 - b. gives a waiver over copyright
 - c. does not confer on its holder a monopoly on the use of any frequency or band
 - d. can be readily transferred

=====

70. A person in distress:
- a. must use correct communication procedures
 - b. may use any means available to attract attention
 - c. must give position with a grid reference
 - d. must use allocated safety frequencies

=====

Section 2 – Frequencies

The Ham band plan is listed below. Learn the **Red** ones.

Wavelength	Lower Limit	Upper Limit	Restrictions
1800m	0.13MHz	0.19MHz	Power less than 5W
160m	1.8MHz	1.95MHz	
80m	3.5MHz	3.9MHz	
40m	7MHz	7.3MHz	7.1-7.3MHz is on secondary shared usage
30m	10.1MHz	10.15MHz	Morse, Digital modes only
20m	14MHz	14.35MHz	
17m	18.068MHz	18.168MHz	
15m	21MHz	21.45MHz	
12m	24.89MHz	24.99MHz	
11m	26.95MHz	27.3MHz	Telemetry or Telecontrol only - 5W Max
10m	28MHz	29.7MHz	
6m	50MHz	54MHz	
2m	144MHz	148MHz	
70cm	430MHz	440MHz	
32cm	915MHz	928MHz	25W max
23cm	1240MHz	1300MHz	
12cm	2396MHz	2450MHz	
9cm	3300MHz	3410MHz	
5cm	5650MHz	5850MHz	
3cm	10GHz	10.5GHz	
1.2cm	24GHz	24.25GHz	
6mm	47GHz	47.2GHz	
4mm	75.5GHz	81GHz	

A new ham can transmit on any band below 5MHz or above 25MHz, for the first 3 months. Access is granted to the 5-25MHz portion on presentation of a log book containing 50 contacts for inspection, after 3 months.

All amateurs have equal rights to the bands

Some bands are shared with other services. Hams may operate within these shared bands, provided they do not cause harmful interference to the other primary user.

Shared bands include

7.1-7.3 MHz in the 40m band

51-54 MHz in the 6m band

146-148 MHz in the 2m band

NZ operators have the following band on a primary basis

21-21.45MHz the 15m band

The band plans include portions for narrow bandwidths of transmission e.g. Morse code. This is to alleviate interference issues between users of different modes. The band plans were developed by NZART in the interest of all hams in NZ. These band plans are recommended, and all amateurs should follow them.

Question File: 2. Frequencies: (2 questions)

1. Amateur stations are often regarded as "frequency agile". This means:
 - a. operation is limited to frequency modulation
 - b. operators can choose to operate anywhere on a shared band
 - c. a bandswitch is required on all transceivers
 - d. on a shared band operators can change frequency to avoid interfering

=====
2. A new amateur radio operator is permitted to:
 - a. operate on all amateur bands other than VHF at least weekly using a computer for log-keeping
 - b. operate only on specified amateur bands for 3 months logging at least 50 contacts and retaining the log book for at least one year for possible official inspection
 - c. operate only on one fixed frequency in the amateur bands between 5 and 25 MHz for 6 months and then present the log book for official inspection
 - d. operate on amateur bands between 5 and 25 MHz as and when the operator chooses

=====
3. The frequency limits of the "80 metre band" are:
 - a. 3.50 to 4.0 MHz
 - b. 3.50 to 3.90 MHz
 - c. 3.50 to 3.85 MHz
 - d. 3.6 to 3.9 MHz

=====
4. In New Zealand the frequency limits of the "40 metre band" are:
 - a. 7.00 to 7.10 MHz
 - b. 7.00 to 7.15 MHz
 - c. 7.00 to 7.30 MHz
 - d. 7.10 to 7.40 MHz

=====
5. The frequency limits of the "20 metre band" are:
 - a. 14.00 to 14.10 MHz
 - b. 14.00 to 14.45 MHz
 - c. 14.00 to 14.50 MHz
 - d. 14.00 to 14.35 MHz

=====

6. The frequency limits of the “15 metre band” are:

- a. 21.00 to 21.35 MHz
- b. 21.00 to 21.40 MHz
- c. 21.00 to 21.45 MHz
- d. 21.00 to 21.50 MHz

=====

7. The frequency limits of the “10 metre band” are:

- a. 28.00 to 28.35 MHz
- b. 28.00 to 28.40 MHz
- c. 28.00 to 29.00 MHz
- d. 28.00 to 29.70 MHz

=====

8. The frequency limits of the “2 metre band” are:

- a. 144 to 149 MHz
- b. 144 to 148 MHz
- c. 146 to 148 MHz
- d. 144 to 150 MHz

=====

9. The frequency limits of the “70 centimetre band” are:

- a. 430 to 440 MHz
- b. 430 to 450 MHz
- c. 435 to 438 MHz
- d. 430 to 460 MHz

=====

10. The published bandplans for the New Zealand amateur bands:

- a. are determined by the Ministry of Business, Innovation and Employment
- b. change at each equinox
- c. limit the operating frequencies of high-power stations
- d. were developed by NZART in the interests of all radio amateurs

=====

11. Operation on the 130 to 190 kHz band requires:

- a. a vertical half-wave antenna
- b. special permission to operate in daylight hours
- c. power output limited to 5 watt e.i.r.p. maximum
- d. receivers with computers with sound cards

=====

12. Two bands where amateur satellites may operate are

- a. 28.0 to 29.7 MHz and 144.0 to 146.0 MHz
- b. 21.0 to 21.1 MHz and 146.0 to 148.0 MHz
- c. 3.5 to 3.8 MHz and 7.0 to 7.1 MHz
- d. 7.1 to 7.3 MHz and 10.1 to 10.15 MHz

=====

13. The amateur service is authorized to share a portion of which of the following bands that is heavily used by other non-amateur devices :

- a. 2400 to 2500 MHz
- b. 1240 to 1300 MHz
- c. 144 to 148 MHz
- d. 28 to 29.7 MHz

=====
14. The following amateur radio band is shared with other services:

- a. 14.0 to 14.35 MHz
- b. 7.2 to 7.3 MHz
- c. 18.068 to 18.168 MHz
- d. 144.0 to 146.0 MHz

=====
15. The frequency band 146 to 148 MHz is:

- a. shared with other communication services
- b. allocated exclusively for police communications
- c. exclusive to repeater operation
- d. reserved for emergency communications

=====
16. The following amateur radio band is shared with another service in New Zealand :

- a. 51 to 54 MHz
- b. 144 to 146 MHz
- c. 7.0 to 7.1 MHz
- d. 24.89 to 24.99 MHz

=====
17. The published New Zealand amateur radio bandplans are:

- a. obligatory for all amateur radio operators to observe
- b. recommended, and all amateur radio operators should follow them
- c. to show where distant stations can be worked
- d. for tests and experimental purposes only

=====
18. The following band is allocated to New Zealand amateur radio operators on a primary basis:

- a. 3.5 to 3.9 MHz
- b. 10.1 to 10.15 MHz
- c. 146 to 148 MHz
- d. 21 to 21.45 MHz

=====
19. When the Amateur Service is a secondary user of a band and another service is the primary user, this means:

- a. nothing at all, all users have equal rights to operate
 - b. amateurs may only use the band during emergencies
 - c. the band may be used by amateurs provided they do not cause harmful interference to primary users
 - d. you may increase transmitter power to overcome any interference caused by primary users
- =====

20. This rule applies if two amateur radio stations want to use the same frequency:
- a. the operator with the newer licence must yield the frequency to the more experienced licensee
 - b. the station with the lower power output must yield the frequency to the station with the higher power output
 - c. both stations have an equal right to operate on the frequency, the second-comer courteously giving way after checking that the frequency is in use
 - d. stations in ITU Regions 1 and 2 must yield the frequency to stations in Region 3

=====

Section 3 – Electronics Fundamentals

Conductors, Insulators, and Semiconductors

The following materials conduct electricity well, thus are called conductors (in order of conductivity)

- Silver
- Copper
- Aluminum
- Most other metals

Insulators that do not conduct electricity include

- Plastics
- Ceramics
- Glass
- Porcelain
- Air

Semiconductors do not insulate, but they do not conduct electricity well. Some common semiconductors are

- Silicon
- Germanium

There are 2 types of semiconductors – n-type and p-type.

n-type – the current is carried by the electrons

p-type – the current is carried by the holes (or missing electrons)

Thermodynamics

As the temperature of an object increases, the atoms vibrate more. In conductors and semiconductors, this causes their resistance to increase slightly.

Atomic Structure

An atom is made of a nucleus, containing protons and neutrons, and of electrons that orbit the nucleus. Protons have a positive charge, Electrons have a negative charge.

Parts of the Atom

All atoms are more or less the same size, but different atoms are made differently. The atom is made of tiny bits of energy called [subatomic particles](#), and each type of atom has a different number of particles. These particles are organized inside the atom in a definite pattern.

Because the particles are not matter themselves, just energy, they don't behave like matter. Sometimes it is useful to imagine them like little balls, and often diagrams of the atom show them that way, but subatomic particles are definitely not little balls. Subatomic particles are truly weird. Yet the way they act explains a great many things about matter, such as compounds, elements, nuclear bombs, electricity, and how you digest your food, to name only a few.

Structure of the Atom

Around the outside of the atom there are tiny particles called [electrons](#). Electrons move constantly. Each electron has a negative electrical charge. Electrons can move away from the atom sometimes. They can be shared between atoms, or they can go from one atom to another. Electrons can even move through matter, which is what causes electricity. Electrons are very light and incredibly small.

In the centre of the atom (the [nucleus](#)) are the bigger, heavier parts of the atom. There are two types of particle in the nucleus. One of them is the [neutron](#), a particle with no charge. The other type of particle is the [proton](#), a particle with a positive charge.

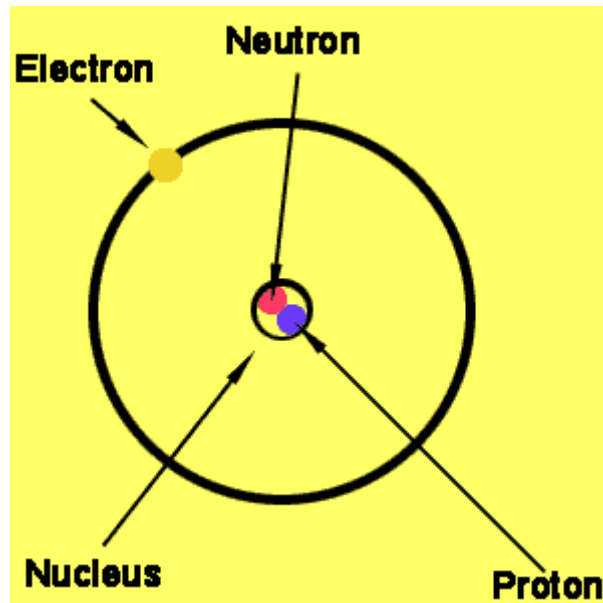

Is this what an atom looks like? Well, no, not really.
Is it a diagram which shows some basic ideas about the atom? Yes.

Electricity is the flow of electrons. In metallic compounds, the electrons are free to flow from one atom to another, thus the metallic compound can conduct electricity.

An insulator will not share its electrons, and thus because the electrons can not leave their atom, they do not conduct electricity.

A normal atom will have the same number of electrons as protons. The positive and negative charges will cancel out. If an atom has too many or too few electrons, the charges will not cancel. This type of atom is called an ion. It will have a charge. Too few electrons and the ion will have a positive charge. Too many electrons and it will have a negative charge.

Electricity sources

A battery is a common source of electricity. It has a negative terminal, that has too many electrons in it, and a positive terminal, that has too few electrons in it. The flow of electricity, called current, is made from the electrons traveling. Current as we know it goes from positive to negative. However, if you could see what was

happening in the wire, the electronics would really be traveling from negative to positive.

Some batteries can be recharged. A common example is the lead acid battery.

Magnetism

A magnet will have a North and South Pole. Like poles repel each other and opposite poles attract. Any wire carrying electric current will produce a magnetic field circling the wire.

Question File: 3. Electronics Fundamentals: (2 questions)

1. The element Silicon is:
 - a. a conductor
 - b. an insulator
 - c. a superconductor
 - d. a semiconductor**

=====
2. An element which falls somewhere between being an insulator and a conductor is called a:
 - a. P-type conductor
 - b. intrinsic conductor
 - c. semiconductor**
 - d. N-type conductor

=====
3. In an atom:
 - a. the protons and the neutrons orbit the nucleus in opposite directions
 - b. the protons orbit around the neutrons
 - c. the electrons orbit the nucleus**
 - d. the electrons and the neutrons orbit the nucleus

=====
4. An atom that loses an electron becomes:
 - a. a positive ion**
 - b. an isotope
 - c. a negative ion
 - d. a radioactive atom

=====
5. An electric current passing through a wire will produce around the conductor:
 - a. an electric field
 - b. a magnetic field**
 - c. an electrostatic field
 - d. nothing

=====

6. These magnetic poles repel:
- a. unlike
 - b. like**
 - c. positive
 - d. negative

- =====
7. A common use for a permanent magnet is:
- a. A computer speaker**
 - b. An optical mouse
 - c. A keyboard
 - d. A magnetic loop antenna

- =====
8. The better conductor of electricity is:
- a. copper**
 - b. carbon
 - c. silicon
 - d. aluminium

- =====
9. The term describing opposition to electron flow in a metallic circuit is:
- a. current
 - b. voltage
 - c. resistance**
 - d. power

- =====
10. The substance which will most readily allow an electric current to flow is:
- a. an insulator
 - b. a conductor**
 - c. a resistor
 - d. a dielectric

- =====
11. The plastic coating formed around wire is:
- a. an insulator**
 - b. a conductor
 - c. an inductor
 - d. a magnet

- =====
12. The following is a source of electrical energy:
- a. p-channel FET
 - b. carbon resistor
 - c. germanium diode
 - d. lead acid battery**
- =====

13. An important difference between a common torch battery and a lead acid battery is that only the lead acid battery:

- a. has two terminals
- b. contains an electrolyte
- c. can be re-charged
- d. can be effectively discharged

=====
14. As temperature increases, the resistance of a metallic conductor:

- a. increases
- b. decreases
- c. remains constant
- d. become a negative

=====
15. In an n-type semiconductor, the current carriers are:

- a. holes
- b. electrons
- c. positive ions
- d. photons

=====
16. In a p-type semiconductor, the current carriers are:

- a. photons
- b. electrons
- c. positive ions
- d. holes

=====
17. An electrical insulator:

- a. lets electricity flow through it in one direction
- b. does not let electricity flow through it
- c. lets electricity flow through it when light shines on it
- d. lets electricity flow through it

=====
18. Four good electrical insulators are:

- a. plastic, rubber, wood, carbon
- b. glass, wood, copper, porcelain
- c. paper, glass, air, aluminium
- d. glass, air, plastic, porcelain

=====
19. Three good electrical conductors are:

- a. copper, gold, mica
 - b. gold, silver, wood
 - c. gold, silver, aluminium
 - d. copper, aluminium, paper
- =====

20. The name for the flow of electrons in an electric circuit is:
- a. voltage
 - b. resistance
 - c. capacitance
 - d. current

=====

Section 4 – Measurement

Electrical properties are measured in units. Some common units are listed below

Measure	Measured in (Unit)	Symbol
Electrical Potential Difference (E)	Volt	V
Electric Current (I)	Ampere (Amp)	A
Electric Resistance or Impedance (R or Z)	Ohm	Ω
Power (W)	Watt	W
Capacitance (C)	Farad	F
Inductance (L)	Henry	H
Electrical Charge	Coulomb	C

All these units can be assigned multipliers – just like a kilometer equates to 1000 meters, a kilovolt would equate to 1000 volts.

Common multipliers are listed below

Multiplier	Symbol	multiply by
Pico	p	0.000000000001
Nano	n	0.000000001
Micro	μ	0.000001
Milli	m	0.001
Kilo	k	1000
Mega	M	1000000
Giga	G	1000000000
Tera	T	1000000000000

Thus a milliamp would be 0.001 of an amp, or one thousandth of an amp. A kilohm is 1000 ohms or one thousand ohms.

Impedance, like resistance, is measured in ohms, but it takes into account the reactance of an AC circuit.

Question File: 4. Measurement Units: (1 question)

1. The unit of impedance is the:

- a. ampere
- b. farad
- c. henry
- d. ohm**

=====

2. One kilohm is:

- a. 10 ohm
- b. 0.01 ohm
- c. 0.001 ohm
- d. 1000 ohm**

=====

3. One kilovolt is equal to:

- a. 10 volt
- b. 100 volt
- c. 1000 volt**
- d. 10,000 volt

=====

4. One quarter of one ampere may be written as:

- a. 250 microampere
- b. 0.5 ampere
- c. 0.25 milliampere
- d. 250 milliampere**

=====

5. The watt is the unit of:

- a. power**
- b. magnetic flux
- c. electromagnetic field strength
- d. breakdown voltage

=====

6. The voltage 'two volt' is also:

- a. 2000 mV**
- b. 2000 kV
- c. 2000 uV
- d. 2000 MV

=====

7. The unit for potential difference between two points in a circuit is the:

- a. ampere
 - b. volt**
 - c. ohm
 - d. coulomb
- =====

8. Impedance is a combination of:
- a. reactance with reluctance
 - b. resistance with conductance
 - c. resistance with reactance
 - d. reactance with radiation

=====

9. One mA is:
- a. one millionth of one ampere
 - b. one thousandth of one ampere
 - c. one tenth of one ampere
 - d. one millionth of admittance

=====

10. The unit of resistance is the:
- a. farad
 - b. watt
 - c. ohm
 - d. resistor

=====

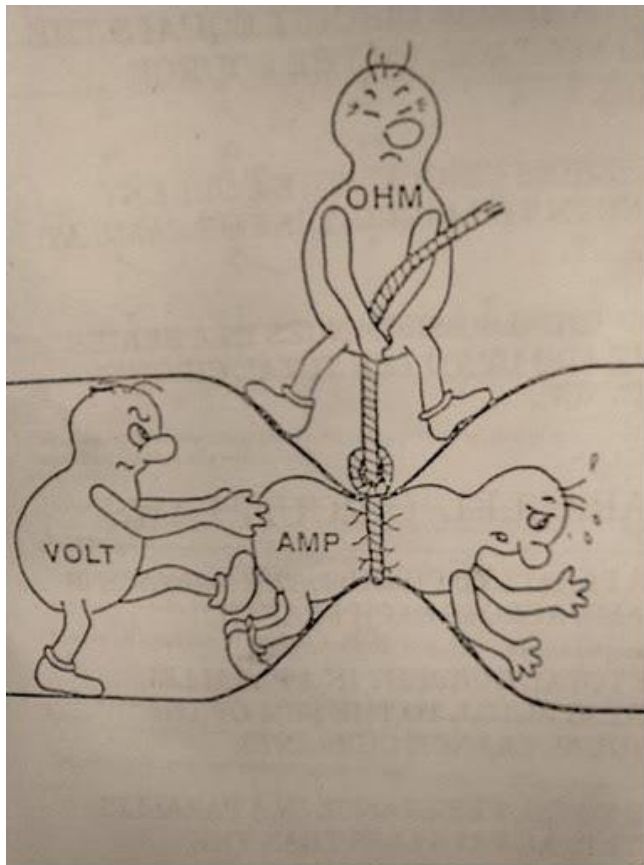

Section 5 – Ohms Law

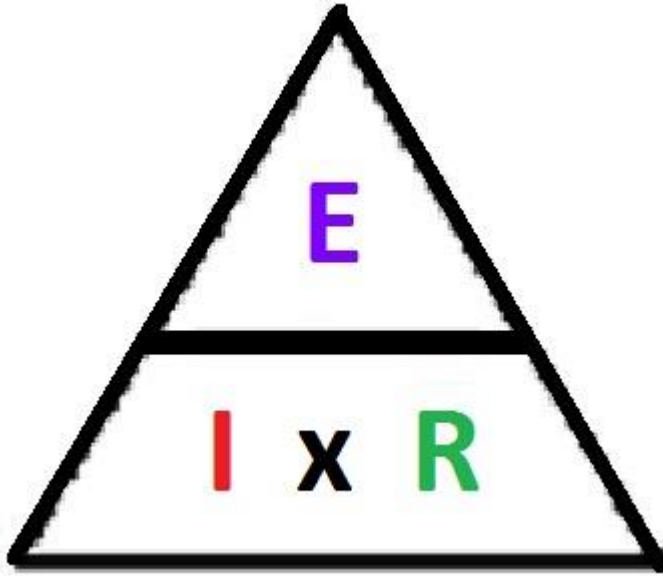

Know this triangle

To use the above triangle, simply cover up the unit you wish to find out (the unknown) and use the other 2 to solve it. V is Voltage, I is Current, R is Resistance.

In some versions V is shown as E for voltage. V and E are interchangeable.

$$E = I \times R \quad I = E / R \quad R = E / I$$

Thus if you know the voltage across a resistor, and the value of resistance, you can calculate the current through the resistor as follows

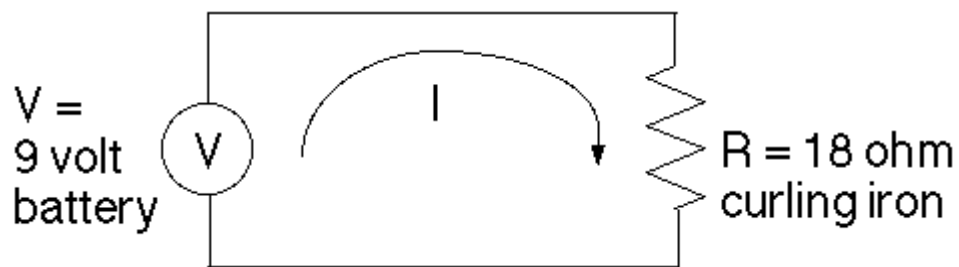

$$I = E / R$$

$$\begin{aligned} \text{Thus } I &= 9 / 18 \\ &= 0.5\text{A} \\ \text{or } I &= 500\text{mA} \end{aligned}$$

eg2

An unknown voltage is applied across a 16 ohm resistor, and the current meter reads 2 amps. What is the unknown voltage?

$$E = I \times R$$

$$E = 2 \times 16$$

$$E = 32V$$

Eg3

The markings have faded on a resistor. We know with ohms law the resistance can be calculated with known voltage and current. A circuit is set up with a battery, the unknown resistor, a voltmeter and current meter. The voltmeter reads 3V and the current meter shows 300mA.

First – the current must be put into standard units.
We know 300mA = 0.3A

Ohms law tells us $R = V / I$
Thus $R = 3 / 0.3$
 $R = 10 \text{ ohms}$

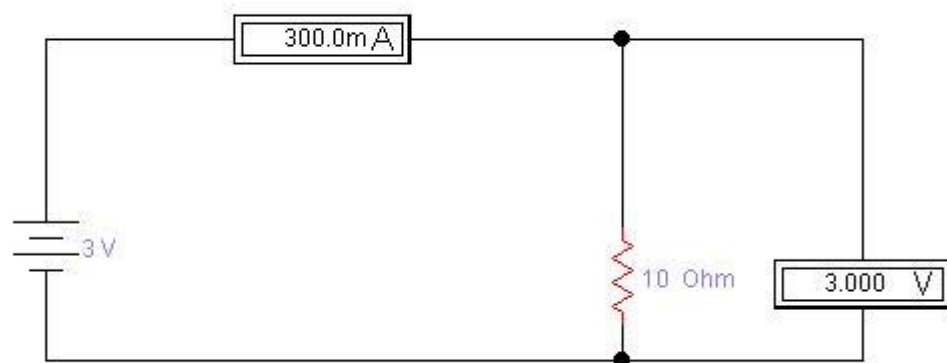

Question File: 5. Ohm's Law: (2 questions)

1. The voltage across a resistor carrying current can be calculated using the formula:
 - a. $E = I + R$ [voltage equals current plus resistance]
 - b. $E = I - R$ [voltage equals current minus resistance]
 - c. $E = I \times R$ [voltage equals current times resistance]
 - d. $E = I / R$ [voltage equals current divided by resistance]

=====

2. A 10 mA current is measured in a 500 ohm resistor. The voltage across the resistor will be:

- a. 5 volt
- b. 50 volt
- c. 500 volt
- d. 5000 volt

3. The value of a resistor to drop 100 volt with a current of 0.8 milliampere is:

- a. 125 ohm
- b. 125 kilohm
- c. 1250 ohm
- d. 1.25 kilohm

4. $I = E/R$ is a mathematical equation describing:

- a. Ohm's Law
- b. Thevenin's Theorem
- c. Kirchoff's First Law
- d. Kirchoff's Second Law

5. The voltage to cause a current of 4.4 ampere in a 50 ohm resistance is:

- a. 2220 volt
- b. 220 volt
- c. 22.0 volt
- d. 0.222 volt

6. A current of 2 ampere flows through a 16 ohm resistance. The applied voltage is:

- a. 8 volt
- b. 14 volt
- c. 18 volt
- d. 32 volt

7. A current of 5 ampere in a 50 ohm resistance produces a potential difference of:

- a. 20 volt
- b. 45 volt
- c. 55 volt
- d. 250 volt

8. This voltage is needed to cause a current of 200 mA to flow in a lamp of 25 ohm resistance:

- a. 5 volt
- b. 8 volt
- c. 175 volt
- d. 225 volt

9. A current of 0.5 ampere flows through a resistance when 6 volt is applied. To change the current to 0.25 ampere the voltage must be:
- increased to 12 volt
 - reduced to 3 volt
 - held constant
 - reduced to zero

10. The current flowing through a resistor can be calculated by using the formula:
- $I = E \times R$ [current equals voltage times resistance]
 - $I = E / R$ [current equals voltage divided by resistance]
 - $I = E + R$ [current equals voltage plus resistance]
 - $I = E - R$ [current equals voltage minus resistance]

11. When an 8 ohm resistor is connected across a 12 volt supply the current flow is:
- 12 / 8 amps
 - 8 / 12 amps
 - 12 - 8 amps
 - 12 + 8 amps

12. A circuit has a total resistance of 100 ohm and 50 volt is applied across it. The current flow will be:
- 50 mA
 - 500 mA
 - 2 ampere
 - 20 ampere

13. The following formula gives the resistance of a circuit:
- $R = I / E$ [resistance equals current divided by voltage]
 - $R = E \times I$ [resistance equals voltage times current]
 - $R = E / R$ [resistance equals voltage divided by resistance]
 - $R = E / I$ [resistance equals voltage divided by current]

14. A resistor with 10 volt applied across it and passing a current of 1 mA has a value of:
- 10 ohm
 - 100 ohm
 - 1 kilohm
 - 10 kilohm

15. If a 3 volt battery causes 300 mA to flow in a circuit, the circuit resistance is:
- 10 ohm
 - 9 ohm
 - 5 ohm
 - 3 ohm

16. A current of 0.5 ampere flows through a resistor when 12 volt is applied. The value of the resistor is:

- a. 6 ohms
- b. 12.5 ohms
- c. 17 ohms
- d. 24 ohms

=====

17. The resistor which gives the greatest opposition to current flow is:

- a. 230 ohm
- b. 1.2 kilohm
- c. 1600 ohm
- d. 0.5 megohm

=====

18. The ohm is the unit of:

- a. supply voltage
- b. electrical pressure
- c. current flow
- d. electrical resistance

=====

19. If a 12 volt battery supplies 0.15 ampere to a circuit, the circuit's resistance is:

- a. 0.15 ohm
- b. 1.8 ohm
- c. 12 ohm
- d. 80 ohm

=====

20. If a 4800 ohm resistor is connected to a 12 volt battery, the current flow is:

- a. 2.5 mA
 - b. 25 mA
 - c. 40 A
 - d. 400 A
- =====

Section 6 – Resistance

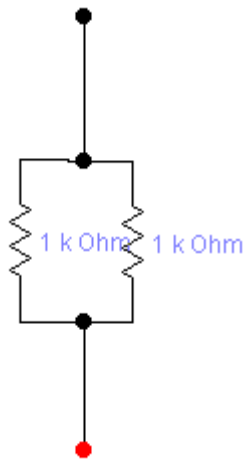

A parallel resistor network



A series resistor network

Formulas

For a series resistance network, the total resistance = the sum of each individual member of the network

$$R_T = R_1 + R_2 + R_3 + \dots$$

In a series network if each resistive component has the same resistance R_x , a simpler formula can be used. n = the number of resistors.

$$R_T = R_x \times n$$

For a parallel resistance network, the reciprocal of the total resistance = the sum of each of the reciprocal resistances

$$R_T^{-1} = R_1^{-1} + R_2^{-1} + R_3^{-1} + \dots$$

In a parallel network if each resistive component has the same resistance R_x , a simpler formula can be used. n = the number of resistors.

$$R_T = R_x / n$$

Thus the following can be said

The **total** resistance in a **series** network will always be **greater** than any one of the resistive components

The **total** resistance in a **parallel** network will always be **less** than any one of the resistive components

Eg1

Calculate the total resistance in the following network

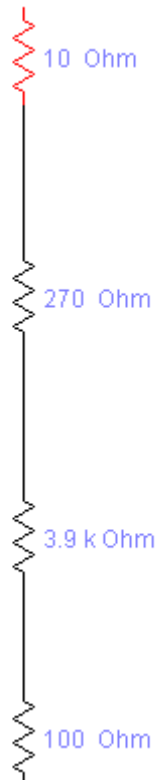

Using the series network formula, we sum the components.

$$\text{Thus } R_T = 10 + 270 + 3900 + 100$$

$$R_T = 4280\Omega$$

Check = is R_T larger than any component – 4280 is larger than 3900 - yes

Eg2

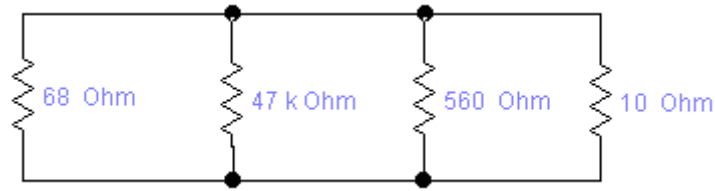

$$R_1^{-1} = 0.0147059$$

$$R_2^{-1} = 0.0000213$$

$$R_3^{-1} = 0.0017857$$

$$R_4^{-1} = 0.1$$

Thus R_T^{-1} = the sum of the above
 $= 0.1165129$

$$R_T = 8.583\Omega$$

Check – is R_T smaller than any component – R_T is less than R_4 10 = yes

NB. R^{-1} is the reciprocal of R . This is sometimes shown as the $1/x$ button or the x^{-1} button on a calculator.

Ohms law applies to all resistive networks. Beware however. Read what the question is asking. If a question asks for the total current in a network – first you must work out the total resistance across the supply, as shown above. However if a question asks for the current in a branch – you need only know the resistance of that branch.

Eg3

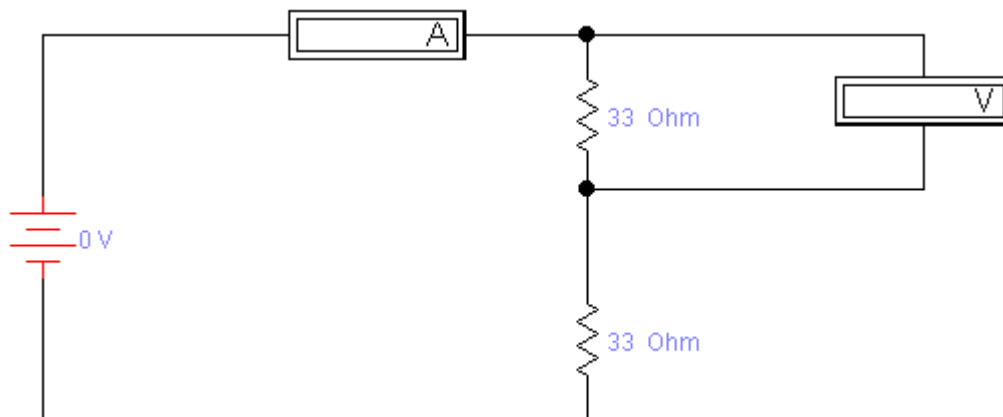

If the current meter reads 100mA, what will the voltmeter read?

Ohms law says $E = I \times R$

$$E_{R1} = I_{R1} \times R_1 \quad I_{R1} = I \text{ in a series circuit, as all the current will pass through } R_1$$

$$E_{R1} = 0.1 \times 33$$

$$E_{R1} = 3.3V$$

Eg4

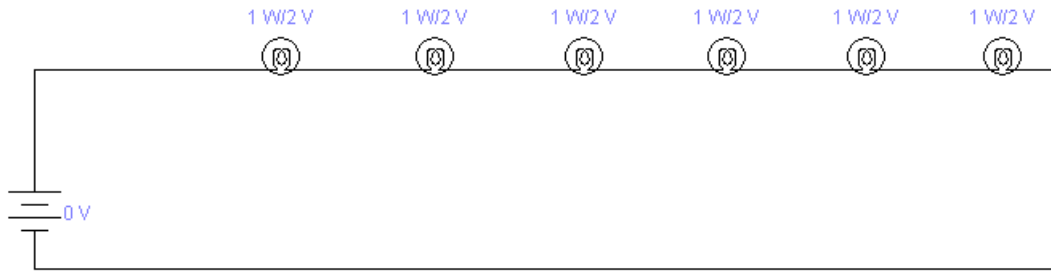

Ignore the wattages indicated above

A string of six 2V lamps are connected in series across a supply. What supply voltage is required so as to ensure that the lamps glow at the same brightness as a single lamp with a 2V supply?

All the resistances are equal, but unknown. However for the lamp to glow correctly, it requires 2V difference across it. Thus for 6 lamps the total voltage will be $6 \times 2V = 12V$.

Question File: 6. Resistance: (3 questions)

1. The total resistance in a parallel circuit:
 - a. is always less than the smallest resistance
 - b. depends upon the voltage drop across each branch
 - c. could be equal to the resistance of one branch
 - d. depends upon the applied voltage

=====
2. Two resistors are connected in parallel and are connected across a 40 volt battery. If each resistor is 1000 ohms, the total battery current is:
 - a. 40 ampere
 - b. 40 milliampere
 - c. 80 ampere
 - d. 80 milliampere

=====
3. The total current in a parallel circuit is equal to the:
 - a. current in any one of the parallel branches
 - b. sum of the currents through all the parallel branches
 - c. applied voltage divided by the value of one of the resistive elements
 - d. source voltage divided by the sum of the resistive elements

=====

4. One way to operate a 3 volt bulb from a 9 volt supply is to connect it in:
- series with the supply
 - parallel with the supply
 - series with a resistor
 - parallel with a resistor
- =====
5. You can operate this number of identical lamps, each drawing a current of 250 mA, from a 5A supply:
- 50
 - 30
 - 20
 - 5
- =====
6. Six identical 2-volt bulbs are connected in series. The supply voltage to cause the bulbs to light normally is:
- 12 V
 - 1.2 V
 - 6 V
 - 2 V
- =====
7. This many 12 volt bulbs can be arranged in series to form a string of lights to operate from a 240 volt power supply:
- 12 x 240
 - 240 + 12
 - 240 - 12
 - 240 / 12
- =====
8. Three 10,000 ohm resistors are connected in series across a 90 volt supply. The voltage drop across one of the resistors is:
- 30 volt
 - 60 volt
 - 90 volt
 - 15.8 volt
- =====
9. Two resistors are connected in parallel. R1 is 75 ohm and R2 is 50 ohm. The total resistance of this parallel circuit is:
- 10 ohm
 - 70 ohm
 - 30 ohm
 - 40 ohm
- =====

10. A dry cell has an open circuit voltage of 1.5 volt. When supplying a large current the voltage drops to 1.2 volt. This is due to the cell's:
- a. internal resistance
 - b. voltage capacity
 - c. electrolyte becoming dry
 - d. current capacity
- =====
11. A 6 ohm resistor is connected in parallel with a 30 ohm resistor. The total resistance of the combination is:
- a. 5 ohm
 - b. 8 ohm
 - c. 24 ohm
 - d. 35 ohm
- =====
12. The total resistance of several resistors connected in series is:
- a. less than the resistance of any one resistor
 - b. greater than the resistance of any one resistor
 - c. equal to the highest resistance present
 - d. equal to the lowest resistance present
- =====
13. Five 10 ohm resistors connected in series give a total resistance of:
- a. 1 ohm
 - b. 5 ohms
 - c. 10 ohms
 - d. 50 ohms
- =====
14. Resistors of 10, 270, 3900, and 100 ohm are connected in series. The total resistance is:
- a. 9 ohm
 - b. 3900 ohm
 - c. 4280 ohm
 - d. 10 ohm
- =====
15. This combination of series resistors could replace a single 120 ohm resistor:
- a. five 24 ohm
 - b. six 22 ohm
 - c. two 62 ohm
 - d. five 100 ohm
- =====
16. If a 2.2 megohm and a 100 kilohm resistor are connected in series, the total resistance is:
- a. 2.1 megohm
 - b. 2.11 megohm
 - c. 2.21 megohm
 - d. 2.3 megohm
- =====

17. If ten resistors of equal value R are wired in parallel, the total resistance is:
- a. R
 - b. $10R$
 - c. $10/R$
 - d. $R/10$
- =====
18. The total resistance of four 68 ohm resistors wired in parallel is:
- a. 12 ohm
 - b. 17 ohm
 - c. 34 ohm
 - d. 272 ohm
- =====
19. Resistors of 68 ohm, 47 kilohm, 560 ohm and 10 ohm are connected in parallel. The total resistance is:
- a. less than 10 ohm
 - b. between 68 and 560 ohm
 - c. between 560 and 47 kilohm
 - d. greater than 47 kilohm
- =====
20. The following resistor combination can most nearly replace a single 150 ohm resistor:
- a. four 47 ohm resistors in parallel
 - b. five 33 ohm resistors in parallel
 - c. three 47 ohm resistors in series
 - d. five 33 ohm resistors in series
- =====
21. Two 120 ohm resistors are arranged in parallel to replace a faulty resistor. The faulty resistor had an original value of:
- a. 15 ohm
 - b. 30 ohm
 - c. 60 ohm
 - d. 120 ohm
- =====
22. Two resistors are in parallel. Resistor A carries twice the current of resistor B which means that:
- a. A has half the resistance of B
 - b. B has half the resistance of A
 - c. the voltage across A is twice that across B
 - d. the voltage across B is twice that across B
- =====
23. The smallest resistance that can be made with five 1 k ohm resistors is:
- a. 50 ohm by arranging them in series
 - b. 50 ohm by arranging them in parallel
 - c. 200 ohm by arranging them in series
 - d. 200 ohm by arranging them in parallel
- =====

24. The following combination of 28 ohm resistors has a total resistance of 42 ohm:
- three resistors in series
 - three resistors in parallel
 - a combination of two resistors in parallel, then placed in series with another resistor
 - a combination of two resistors in parallel, then placed in series with another two in parallel
- =====
25. Two 100 ohm resistors connected in parallel are wired in series with a 10 ohm resistor. The total resistance of the combination is:
- 60 ohms
 - 180 ohms
 - 190 ohms
 - 210 ohms
- =====
26. A 5 ohm and a 10 ohm resistor are wired in series and connected to a 15 volt power supply. The current flowing from the power supply is:
- 0.5 ampere
 - 1 ampere
 - 2 ampere
 - 15 ampere
- =====
27. Three 12 ohm resistors are wired in parallel and connected to an 8 volt supply. The total current flow from the supply is:
- 1 ampere
 - 2 amperes
 - 3 amperes
 - 4.5 amperes
- =====
28. Two 33 ohm resistors are connected in series with a power supply. If the current flowing is 100 mA, the voltage across one of the resistors is:
- 66 volt
 - 33 volt
 - 3.3 volt
 - 1 volt
- =====
29. A simple transmitter requires a 50 ohm dummy load. You can fabricate this from:
- four 300 ohm resistors in parallel
 - five 300 ohm resistors in parallel
 - six 300 ohm resistors in parallel
 - seven 300 ohm resistors in parallel
- =====

30. Three 500 ohm resistors are wired in series. Short-circuiting the centre resistor will change the value of the network from:

- a. 1500 ohm to 1000 ohm
- b. 500 ohm to 1000 ohm
- c. 1000 ohm to 500 ohm
- d. 1000 ohm to 1500 ohm

=====

Section 7 – Power Calculations

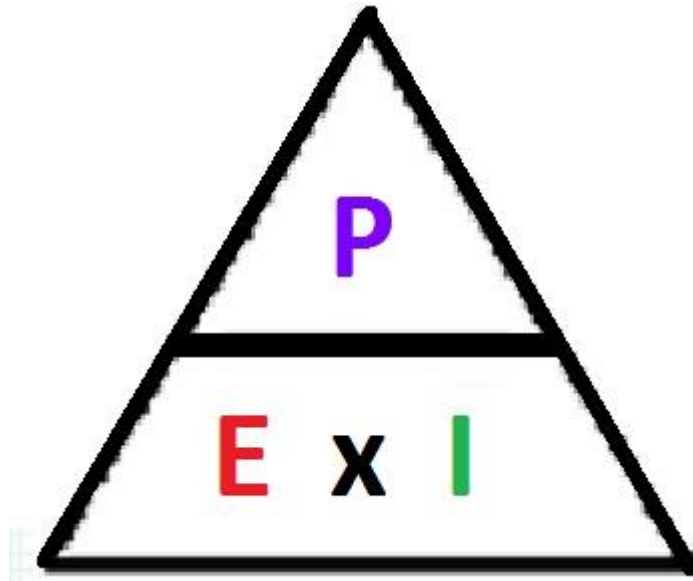

As with ohms law, the power law can be read from the triangle above
 E = Potential Difference (Volts), P = Power (Watts), I = Current (Amps)

$$P = E \times I \quad E = P / I \quad I = P / E$$

Learn the above triangle and remember it.

Eg1

A transmitter power amplifier requires 30mA at 300V. Calculate the DC input power.

We know E and I, and thus need to calculate P

$$\begin{aligned} P &= E \times I \\ &= 300 \times 0.03 \\ &= 9 \text{ W} \end{aligned}$$

Eg2

The current in a 100k Ω resistor is 10mA. What power (heat) is the resistor dissipating?

We know R = 100000 and I = 0.01

Step 1 – We have I and R. We can find E using ohms law.

$$\begin{aligned} E &= I \times R \\ &= 0.01 \times 100000 \\ &= 1000\text{V} \end{aligned}$$

Step 2 – Now that we know E and I calculate P

$$P = E \times I$$

$$= 1000 \times 0.01$$

$$= 10W$$

Eg3

Two 10Ω resistors are connected in series with a 10V battery supplying current. Find the total power load.

Step 1 - Find R_T for a series network

$$R_T = R_1 + R_2$$

$$= 10 + 10$$

$$= 20$$

Step 2 – Find I using ohms law

$$I = E / R$$

$$= 10 / 20$$

$$= 0.5A$$

Step 3 – Find P using the power law

$$P = E \times I$$

$$= 10 \times 0.5$$

$$= 5W$$

Question File: 7. Power calculations: (2 questions)

1. A transmitter power amplifier requires 30 mA at 300 volt. The DC input power is:
 - a. 300 watt
 - b. 9000 watt
 - c. 9 watt**
 - d. 6 watt

- =====
2. The DC input power of a transmitter operating at 12 volt and drawing 500 milliamp would be:

- a. 6 watt**
- b. 12 watt
- c. 20 watt
- d. 500 watt

=====

3. When two 500 ohm 1 watt resistors are connected in series, the maximum total power that can be dissipated by both resistors is:
- a. 4 watt
 - b. 2 watt**
 - c. 1 watt
 - d. 1/2 watt
- =====
4. When two 1000 ohm 5 watt resistors are connected in parallel, they can dissipate a maximum total power of:
- a. 40 watt
 - b. 20 watt
 - c. 10 watt**
 - d. 5 watt
- =====
5. The current in a 100 kilohm resistor is 10 mA. The power dissipated is:
- a. 1 watt
 - b. 10 watt**
 - c. 100 watt
 - d. 10,000 watt
- =====
6. A current of 500 milliamp passes through a 1000 ohm resistance. The power dissipated is:
- a. 0.25 watt
 - b. 2.5 watt
 - c. 25 watt
 - d. 250 watt**
- =====
7. A 20 ohm resistor carries a current of 0.25 ampere. The power dissipated is:
- a. 1.25 watt**
 - b. 5 watt
 - c. 2.50 watt
 - d. 10 watt
- =====
8. If 200 volt is applied to a 2000 ohm resistor, the resistor will dissipate:
- a. 20 watt**
 - b. 30 watt
 - c. 10 watt
 - d. 40 watt
- =====
9. The power delivered to an antenna is 500 watt. The effective antenna resistance is 20 ohm. The antenna current is:
- a. 25 amp
 - b. 2.5 amp
 - c. 10 amp
 - d. 5 amp**
- =====

10. The unit for power is the:
- a. ohm
 - b. watt**
 - c. ampere
 - d. volt

- =====
11. The following two quantities should be multiplied together to find power:
- a. resistance and capacitance
 - b. voltage and current**
 - c. voltage and inductance
 - d. inductance and capacitance

- =====
12. The following two electrical units multiplied together give the unit "watt":
- a. volt and ampere**
 - b. volt and farad
 - c. farad and henry
 - d. ampere and henry

- =====
13. The power dissipation of a resistor carrying a current of 10 mA with 10 volt across it is:
- a. 0.01 watt
 - b. 0.1 watt**
 - c. 1 watt
 - d. 10 watt

- =====
14. If two 10 ohm resistors are connected in series with a 10 volt battery, the battery load is:
- a. 5 watt**
 - b. 10 watt
 - c. 20 watt
 - d. 100 watt

- =====
15. Each of 9 resistors in a circuit is dissipating 4 watt. If the circuit operates from a 12 volt supply, the total current flowing in the circuit is:
- a. 48 ampere
 - b. 36 ampere
 - c. 9 ampere
 - d. 3 ampere**

- =====
16. Three 18 ohm resistors are connected in parallel across a 12 volt supply. The total power dissipation of the resistor load is:
- a. 3 watt
 - b. 18 watt
 - c. 24 watt**
 - d. 36 watt
- =====

17. A resistor of 10 kilohm carries a current of 20 mA. The power dissipated in the resistor is:
- a. 2 watt
 - b. 4 watt
 - c. 20 watt
 - d. 40 watt
- =====
18. A resistor in a circuit becomes very hot and starts to burn. This is because the resistor is dissipating too much:
- a. current
 - b. voltage
 - c. resistance
 - d. power
- =====
19. A current of 10 ampere rms at a frequency of 50 Hz flows through a 100 ohm resistor. The power dissipated is:
- a. 500 watt
 - b. 707 watt
 - c. 10,000 watt
 - d. 50,000 watt
- =====
20. The voltage applied to two resistors in series is doubled. The total power dissipated will:
- a. increase by four times
 - b. decrease to half
 - c. double
 - d. not change
- =====

Section 8 – Alternating Current

Direct Current DC – The current travels in one direction

Alternating Current AC – The current reverses direction periodically

Frequency – The rate at which the alternating current reverses direction

Frequency is measured in Hertz (Hz)

1Hz = 1 complete cycle per second

So in NZ we have a 50Hz mains supply, thus 50 cycles occur every second.

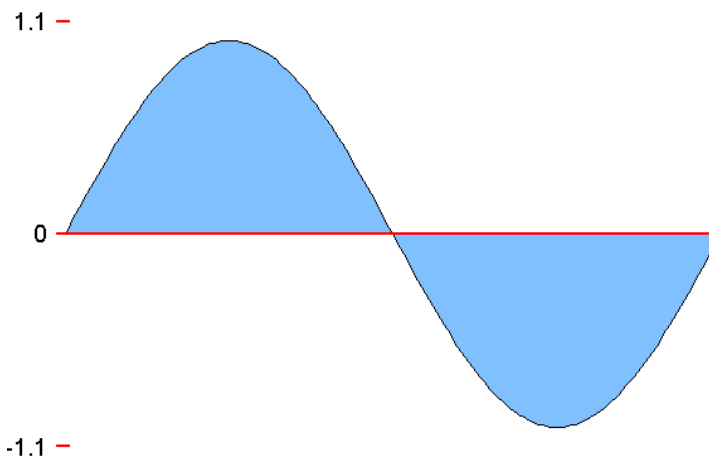

The above is a diagram of one sinusoidal cycle. This is the purest of waves, as it is based upon a rotating circle. On the Y axis is voltage or current, and on the X axis is time.

Period – the time it takes for one cycle to occur. This is the reciprocal of frequency.

$$T = F^{-1} \qquad F = T^{-1}$$

Eg1

What is the time it takes for one complete cycle of a 100Hz signal?

$$\begin{aligned} T &= F^{-1} \\ &= 100^{-1} \\ &= 0.01\text{s} \end{aligned}$$

A harmonic is a multiple of a base signal. If a base signal was 2kHz, its 2nd harmonic would be 4kHz, and its 3rd harmonic would be 6kHz, etc.

Harmonics can occur in electronic oscillators (circuits to create AC waves), and can often be harmful as they are a common source of interference.

RMS is a way of measuring the “average” voltage or current in a sine wave. It is not a real average, as this figure would be different. It allows the power and ohms

laws to apply to an AC circuit. Let me say that again. **RMS voltage and current values are the only values to be used in ohms law and power law.**

The RMS value is 0.707 of the Peak value. (Actually it's the reciprocal of the square root of 2, but 0.707 is close enough for us)

Thus in NZ, we have a supply voltage of 230Vac, at 50Hz. This tells us that our RMS voltage is 230V, and or frequency is 50Hz. Our peak voltage therefore, is larger than this, and can be calculated.

$$230 / 0.707 = 325.3V$$

Eg2

Calculate the RMS current in an AC circuit, if it is known the current peaks at 10A.

$$10A \times 0.707 = 7.07A$$

Question File: 8. Alternating current: (1 question)

1. An 'alternating current' is so called because:

- a. **it reverses direction periodically**
- b. it travels through a circuit using alternate paths
- c. its direction of travel is uncertain
- d. its direction of travel can be altered by a switch

=====

2. The time for one cycle of a 100 Hz signal is:

- a. 1 second
- b. **0.01 second**
- c. 0.0001 second
- d. 10 seconds

=====

3. A 50 hertz current in a wire means that:

- a. a potential difference of 50 volts exists across the wire
- b. the current flowing in the wire is 50 amperes
- c. the power dissipated in the wire is 50 watts
- d. **a cycle is completed 50 times in each second**

=====

4. The current in an AC circuit completes a cycle in 0.1 second. So the frequency is:

- a. 1 Hz
 - b. **10 Hz**
 - c. 100 Hz
 - d. 1000 Hz
- =====

5. An impure signal is found to have 2 kHz and 4 kHz components. This 4 kHz signal is:

- a. a fundamental of the 2 kHz signal
- b. a sub-harmonic of 2 kHz
- c. the DC component of the main signal
- d. a harmonic of the 2 kHz signal

6. The correct name for the equivalent of 'one cycle per second' is one:

- a. henry
- b. volt
- c. hertz
- d. coulomb

7. One megahertz is equal to:

- a. 0.0001 Hz
- b. 100 kHz
- c. 1000 kHz
- d. 10 Hz

8. One GHz is equal to:

- a. 1000 kHz
- b. 10 MHz
- c. 100 MHz
- d. 1000 MHz

9. The 'rms value' of a sine-wave signal is:

- a. half the peak voltage
- b. 1.414 times the peak voltage
- c. the peak-to-peak voltage
- d. 0.707 times the peak voltage

10. A sine-wave alternating current of 10 ampere peak has an rms value of:

- a. 5 amp
- b. 7.07 amp
- c. 14.14 amp
- d. 20 amp

Section 9 – Capacitors, Inductors, and Resonance

Capacitors are 2 plates of metal separated by a dielectric (possibly air). Their Capacitance is measured in Farads (F) but as 1 Farad is very large, capacitors are often measured in picofarads for very small capacitors, or more commonly microfarads.

The closer the metal plates, the higher the capacitance, but the lower the working voltage.

Capacitors are placed in parallel to increase the total capacitance.

$$C_T = C_1 + C_2 + C_3 + \dots$$

Capacitors have a maximum working voltage, above which point the capacitor will breakdown.

Capacitors are placed in series to increase their maximum working voltage.

$$C_{ET} = C_{E1} + C_{E2} + C_{E3} + \dots \text{ (you don't need to remember this)}$$

A capacitor in a series circuit will block DC. It will let AC pass depending on the frequency. The higher frequency the less reactance it will have. Higher frequency AC flows through a capacitor easier.

Inductors are made from coiling wire around a former (possibly air). Their inductance is measured in Henry (H), but you will more likely find them measured in micro and millihenry.

The more turns of wire, the more inductance an inductor will have.

Inductors placed in series will increase the total inductance.

$$L_T = L_1 + L_2 + L_3 + \dots$$

Inductors placed in parallel will decrease the total inductance.

$$L_T^{-1} = L_1^{-1} + L_2^{-1} + L_3^{-1} + \dots$$

Inductors will block higher frequency AC current, but will let lower frequency AC and DC current pass through. The amount of resisting to AC current in an inductor is referred to as reactance also. The higher the frequency, the higher the reactance in an inductor.

Toroidal inductors are those formed on a donut style (closed loop) former.

Reactance, X

Reactance (symbol X) is a measure of the opposition of capacitance and inductance to current. Reactance varies with the frequency of the electrical signal. Reactance is measured in ohms, symbol Ω .

There are two types of reactance: capacitive reactance (X_C) and inductive reactance (X_L).

The **total reactance (X)** is the *difference* between the two: $X = X_L - X_C$

- **Capacitive reactance, X_C**

$$X_C = \frac{1}{2\pi f C} \quad \text{where: } \begin{array}{l} X_C = \text{reactance in ohms } (\Omega) \\ f = \text{frequency in hertz (Hz)} \\ C = \text{capacitance in farads (F)} \end{array}$$

- X_C is large at low frequencies and small at high frequencies. For steady DC which is zero frequency, X_C is infinite (total opposition), hence the rule that **capacitors pass AC but block DC**.
- For example: a $1\mu\text{F}$ capacitor has a reactance of $3.2\text{k}\Omega$ for a 50Hz signal, but when the frequency is higher at 10kHz its reactance is only 16Ω .
- **Inductive reactance, X_L**

$$X_L = 2\pi f L \quad \text{where: } \begin{array}{l} X_L = \text{reactance in ohms } (\Omega) \\ f = \text{frequency in hertz (Hz)} \\ L = \text{inductance in henrys (H)} \end{array}$$

- X_L is small at low frequencies and large at high frequencies. For steady DC (frequency zero), X_L is zero (no opposition), hence the rule that **inductors pass DC but block high frequency AC**.
- For example: a 1mH inductor has a reactance of only 0.3Ω for a 50Hz signal, but when the frequency is higher at 10kHz its reactance is 63Ω .

Transformers are 2 separate inductors wound on a common former, used to change an AC voltage. The voltages can be worked out by the turns ratio.

Eg. A transformer has 100 turns on its primary winding, and 10 turns on its secondary winding. 230V is applied to the primary. What voltage would appear on the secondary winding?

The turns ratio is 100 – 10 or simplified down 10 – 1

Thus every 10 Volts on the primary creates 1 Volt on the secondary for this transformer.

So 230V on the primary of this transformer would give us 23V on the secondary.

Resonance

As capacitors and inductors are complimentary components in an AC circuit, they are often used to form a resonant circuit. A resonant circuit may be used to let pass a particular frequency, or to block a particular frequency.

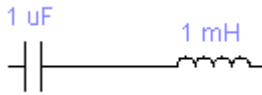

Series resonant circuit. Its impedance is lowest at resonance and acts as a pass filter.

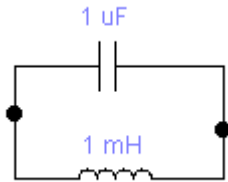

Parallel resonant circuit. Its impedance is highest at resonance and acts as a notch filter.

For both circuits the following rules apply

If the capacitance is increased by a factor of 4, the resonant frequency will decrease to half.

If the inductance is decreased by a factor of 4, the resonant frequency will increase by a factor of 2.

The selectivity of a filter is measured by its Q.

A high Q filter is highly selective, whereas a low Q filter will not be as selective.

Question File: 9. Capacitors, Inductors, Resonance: (2 questions)

1. The total capacitance of two or more capacitors in series is:
 - a. always less than that of the smallest capacitor
 - b. always greater than that of the largest capacitor
 - c. found by adding each of the capacitances together
 - d. found by adding the capacitances together and dividing by their total number

=====

2. Filter capacitors in power supplies are sometimes connected in series to:
- withstand a greater voltage than a single capacitor can withstand
 - increase the total capacity
 - reduce the ripple voltage further
 - resonate the filter circuit

- =====
3. A component is identified as a capacitor if its value is measured in:
- microvolts
 - millihenrys
 - megohms
 - microfarads

- =====
4. Two metal plates separated by air form a 0.001 uF capacitor. Its value may be changed to 0.002 uF by:
- bringing the metal plates closer together
 - making the plates smaller in size
 - moving the plates apart
 - touching the two plates together

- =====
5. The material separating the plates of a capacitor is the:
- dielectric
 - semiconductor
 - resistor
 - lamination

- =====
6. Three 15 picofarad capacitors are wired in parallel. The value of the combination is:
- 45 picofarad
 - 18 picofarad
 - 12 picofarad
 - 5 picofarad

- =====
7. Capacitors and inductors oppose an alternating current. This is known as:
- resistance
 - resonance
 - conductance
 - reactance

- =====
8. The reactance of a capacitor increases as the:
- frequency increases
 - frequency decreases
 - applied voltage increases
 - applied voltage decreases
- =====

9. The reactance of an inductor increases as the:
- a. frequency increases
 - b. frequency decreases
 - c. applied voltage increases
 - d. applied voltage decreases
- =====
10. Increasing the number of turns on an inductor will make its inductance:
- a. decrease
 - b. increase
 - c. remain unchanged
 - d. become resistive
- =====
11. The unit of inductance is the:
- a. farad
 - b. henry
 - c. ohm
 - d. reactance
- =====
12. Two 20 μH inductances are connected in series. The total inductance is:
- a. 10 μH
 - b. 20 μH
 - c. 40 μH
 - d. 80 μH
- =====
13. Two 20 μH inductances are connected in parallel. The total inductance is:
- a. 10 μH
 - b. 20 μH
 - c. 40 μH
 - d. 80 μH
- =====
14. A toroidal inductor is one in which the:
- a. windings are wound on a closed ring of magnetic material
 - b. windings are air-spaced
 - c. windings are wound on a ferrite rod
 - d. inductor is enclosed in a magnetic shield
- =====
15. A transformer with 100 turns on the primary winding and 10 turns on the secondary winding is connected to 230 volt AC mains. The voltage across the secondary is:
- a. 10 volt
 - b. 23 volt
 - c. 110 volt
 - d. 2300 volt
- =====

16. An inductor and a capacitor are connected in series. At the resonant frequency the resulting impedance is:
- a. maximum
 - b. minimum**
 - c. totally reactive
 - d. totally inductive
- =====
17. An inductor and a capacitor are connected in parallel. At the resonant frequency the resulting impedance is:
- a. maximum**
 - b. minimum
 - c. totally reactive
 - d. totally inductive
- =====
18. An inductor and a capacitor form a resonant circuit. The capacitor value is increased by four times. The resonant frequency will:
- a. increase by four times
 - b. double
 - c. decrease to half**
 - d. decrease to one quarter
- =====
19. An inductor and a capacitor form a resonant circuit. If the value of the inductor is decreased by a factor of four, the resonant frequency will:
- a. increase by a factor of four
 - b. increase by a factor of two**
 - c. decrease by a factor of two
 - d. decrease by a factor of four
- =====
20. A "high Q" resonant circuit is one which:
- a. carries a high quiescent current
 - b. is highly selective**
 - c. has a wide bandwidth
 - d. uses a high value inductance
- =====

Section 10 – Safety

First rule of safety – Your own safety is paramount. Never do anything that will put your own safety at risk.

Eg. You find someone unconscious near a high voltage electricity supply. Your first call is to isolate (turn off) the power, before approaching the person to check his well-being. He may still be connected to the supply, and approaching him may mean you end up on the floor beside him.

Never work on any Mains appliance unless you are competent to do so.

Before working on an appliance that uses mains supply, always turn the power off and remove the plug from the outlet.

In a high power transmitter, high voltages are present. The wires are well insulated to avoid short circuits within the amplifier or transmitter.

RCD = Residual Current Device. It constantly measures the phase and neutral currents in an appliance or power system. Should these 2 currents become out of balance, the RCD will disconnect the supply. This is because there is a chance that if the currents are out of balance, they could possibly be electrocuting someone.

A class 1 appliance has a metal outer, that is connected to earth. This is so that if a fault occurs where a live wire comes into contact with the metal frame, it will quickly short circuit the supply and blow the circuit protecting device (or fuse). The purpose then of the earthing conductor is to prevent the metal outer from becoming live.

Wiring in a 230V appliance lead

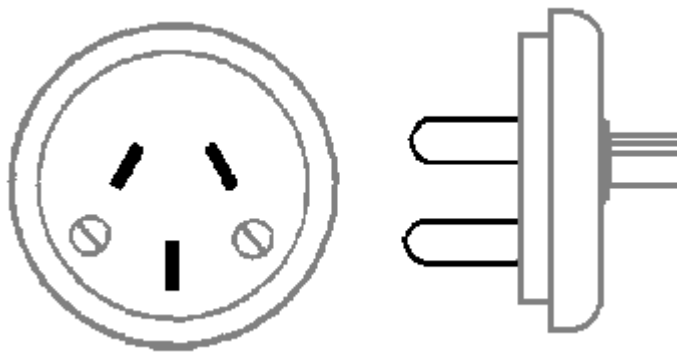
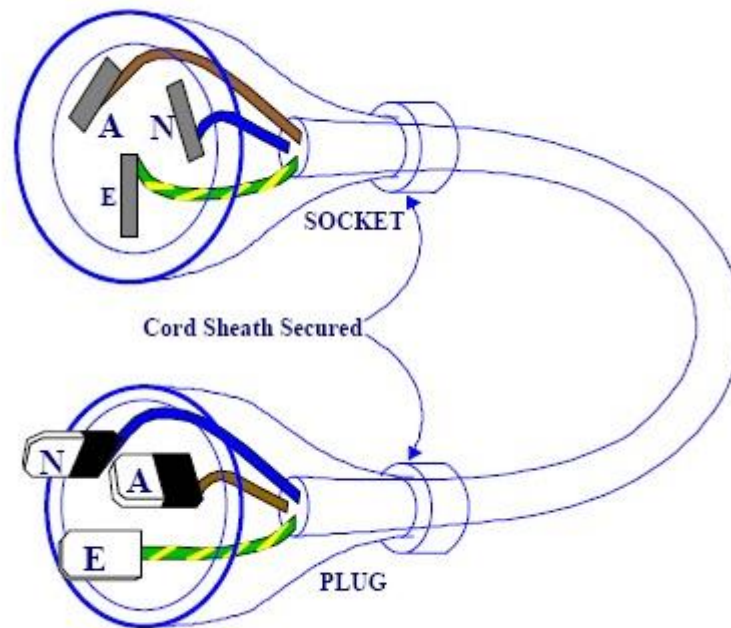

Top left is the phase terminal, or Live. Connect the Red or Brown wire here.

Top right is the neutral terminal. Connect the Black or Blue wire here.

The larger bottom pin is the earth terminal. Connect the Green or the Green and Yellow wire here.

Isolating transformers are another safety device, used to remove the voltage from either the neutral or phase wire to earth. However if you were to come into contact with both the neutral and phase terminals you would still be electrocuted.

This transformer has a winding ratio of 1 – 1.

Question File: 10. Safety: (1 question)

1. You can safely remove an unconscious person from contact with a high voltage source by:
- pulling an arm or a leg
 - wrapping the person in a blanket and pulling to a safe area
 - calling an electrician
 - turning off the high voltage and then removing the person
- =====
2. For your safety, before checking a fault in a mains operated power supply unit, first:
- short the leads of the filter capacitor
 - turn off the power and remove the power plug
 - check the action of the capacitor bleeder resistance
 - remove and check the fuse in the power supply
- =====
3. Wires carrying high voltages in a transmitter should be well insulated to avoid:
- short circuits
 - overheating
 - over modulation
 - SWR effects
- =====
4. A residual current device is recommended for protection in a mains power circuit because it:
- reduces electrical interference from the circuit
 - removes power to the circuit when the phase and neutral currents are not equal
 - removes power to the circuit when the current in the phase wire equals the current in the earth wire
 - limits the power provided to the circuit
- =====
5. An earth wire should be connected to the metal chassis of a mains-operated power supply to ensure that if a fault develops, the chassis:
- does not develop a high voltage with respect to earth
 - does not develop a high voltage with respect to the phase lead
 - becomes a conductor to bleed away static charge
 - provides a path to ground in case of lightning strikes
- =====
6. The purpose of using three wires in the mains power cord and plug on amateur radio equipment is to:
- make it inconvenient to use
 - prevent the chassis from becoming live in case of an internal short to the chassis
 - prevent the plug from being reversed in the wall outlet
 - prevent short circuits
- =====

7. The correct colour coding for the phase wire in a flexible mains lead is:
- a. brown
 - b. blue
 - c. yellow and green
 - d. white

=====

8. The correct colour coding for the neutral wire in a flexible mains lead is:
- a. brown
 - b. blue
 - c. yellow and green
 - d. white

=====

9. The correct colour coding for the earth wire in a flexible mains lead is:
- a. brown
 - b. blue
 - c. yellow and green
 - d. white

=====

10. An isolating transformer is used to:
- a. ensure that faulty equipment connected to it will blow a fuse in the distribution board
 - b. ensure that no voltage is developed between either output lead and ground
 - c. ensure that no voltage is developed between the output leads
 - d. step down the mains voltage to a safe value

=====

Section 11 – Semiconductors

Diode

A diode is an electronic device used to conduct current in one direction only. It is made from 2 types of semiconductor – P material and N material. The electrons, when forward biased (or forward voltage) will pass from the N material to the P material. During this process some voltage is lost. For Silicon this is 0.7V. For Germanium it is 0.3V. Silicon diodes are often used in power supplies to convert AC into DC. Diodes also have a maximum reverse voltage that, once exceeded, will destroy the diode.

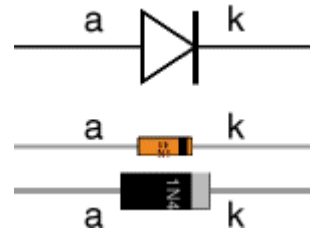

Diodes have 2 connections, the anode and the cathode. Current flows only from the anode to the cathode.

Diodes are also used to recover information from a received radio signal, a process called demodulating.

Zener diodes have a lower reverse voltage, and with proper current limiting, can be used to create a regulated voltage source.

A varactor diode has variable capacitance.

Transistors are an electronic component used to amplify current. The most common form of transistor is a bipolar transistor. These come in 2 varieties – the NPN and the PNP transistor. They have 3 terminals, the base, the collector, and the emitter.

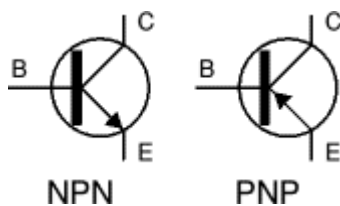

If the base is above (for NPN) or below (for PNP) the voltage at the emitter, by more than 0.7V, (as they are a Silicon device) the transistor will turn on. If the base is at the same potential as the emitter, the transistor will be off.

Transistors can be destroyed by excessive voltage, current, or heat. (created by a combination of excessive current x voltage or power)

A simple transistor circuit is shown below.

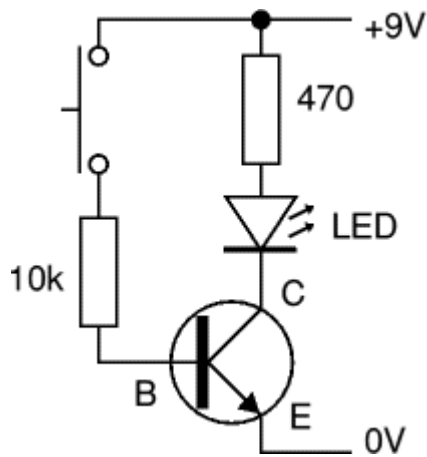

Pressing the push button will allow a small current to flow through the base and out the emitter. The transistor will then allow a much larger current to flow from the collector to the emitter thus turning the LED (Light Emitting Diode) on.

Field Effect transistors have similar properties to Bipolar transistors, but have much higher gain. This is because the gate has a much higher impedance than the base of the bipolar transistor. The symbol for the JFET is shown below. The gate is the terminal with the arrow, the other terminals are called the source and drain. The one on the left is an N channel JFET, and the one on the right is a P channel JFET

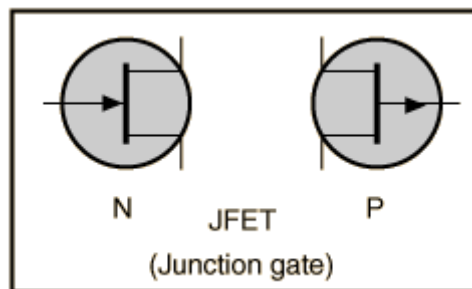

Question File: 11. Semiconductors: (2 questions)

1. The basic semiconductor amplifying device is a:
 - a. diode
 - b. transistor**
 - c. pn-junction
 - d. silicon gate

=====

2. Zener diodes are normally used as:
- RF detectors
 - AF detectors
 - current regulators
 - voltage regulators**
- =====
3. The voltage drop across a germanium signal diode when conducting is about:
- 0.3V**
 - 0.6V
 - 0.7V
 - 1.3V
- =====
4. A bipolar transistor has three terminals named:
- base, emitter and drain
 - collector, base and source
 - emitter, base and collector**
 - drain, source and gate
- =====
5. The three leads from a PNP transistor are named the:
- collector, source, drain
 - gate, source, drain
 - drain, base, source
 - collector, emitter, base**
- =====
6. A low-level signal is applied to a transistor circuit input and a higher-level signal is present at the output. This effect is known as:
- amplification**
 - detection
 - modulation
 - rectification
- =====
7. The type of rectifier diode in almost exclusive use in power supplies is:
- lithium
 - germanium
 - silicon**
 - copper-oxide
- =====
8. One important application for diodes is recovering information from transmitted signals. This is referred to as:
- biasing
 - rejuvenation
 - ionisation
 - demodulation**
- =====

9. In a forward biased pn junction, the electrons:
- flow from p to n
 - flow from n to p
 - remain in the n region
 - remain in the p region
- =====
10. The following material is considered to be a semiconductor:
- copper
 - sulphur
 - silicon
 - tantalum
- =====
11. A varactor diode acts like a variable:
- resistance
 - voltage regulator
 - capacitance
 - inductance
- =====
12. A semiconductor is said to be doped when small quantities of the following are added:
- electrons
 - protons
 - ions
 - impurities
- =====
13. The connections to a semiconductor diode are known as:
- cathode and drain
 - anode and cathode
 - gate and source
 - collector and base
- =====
14. Bipolar transistors usually have:
- 4 connecting leads
 - 3 connecting leads
 - 2 connecting leads
 - 1 connecting lead
- =====
15. A semiconductor is described as a "general purpose audio NPN device". This is a:
- triode
 - silicon diode
 - bipolar transistor
 - field effect transistor
- =====

16. Two basic types of bipolar transistors are:

- a. p-channel and n-channel types
- b. NPN and PNP types**
- c. diode and triode types
- d. varicap and zener types

=====

17. A transistor can be destroyed in a circuit by:

- a. excessive light
- b. excessive heat**
- c. saturation
- d. cut-off

=====

18. To bias a transistor to cut-off, the base must be:

- a. at the collector potential
- b. at the emitter potential**
- c. mid-way between collector and emitter potentials
- d. mid-way between the collector and the supply potentials

=====

19. Two basic types of field effect transistors are:

- a. n-channel and p-channel**
- b. NPN and PNP
- c. germanium and silicon
- d. inductive and capacitive

=====

20. A semiconductor with leads labelled gate, drain and source, is best described as a:

- a. bipolar transistor
- b. silicon diode
- c. gated transistor
- d. field-effect transistor**

=====

Section 12 – Device Recognition

Bipolar transistors.

Bipolar NPN

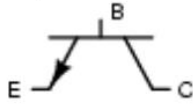

Bipolar PNP

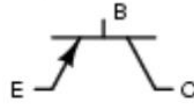

... with case

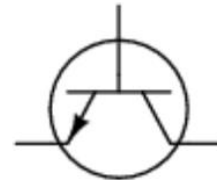

For the NPN the arrow points outward. The PNP the arrow points in.

Field Effect transistors

N-channel

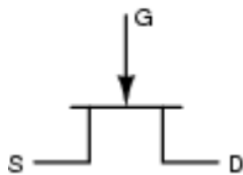

P-channel

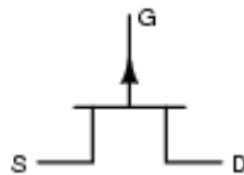

... with case

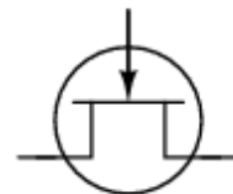

<p>S = Source G = Gate D = Drain</p>
--

The N channel arrow points in, the P channel arrow points out.

MOSFET's

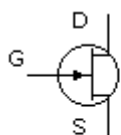

J-FET

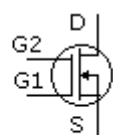

DG MOSFET

The dual gate mosfet has 2 gates, a source and a drain.

Vacuum Tubes (Valves)

Tetrode

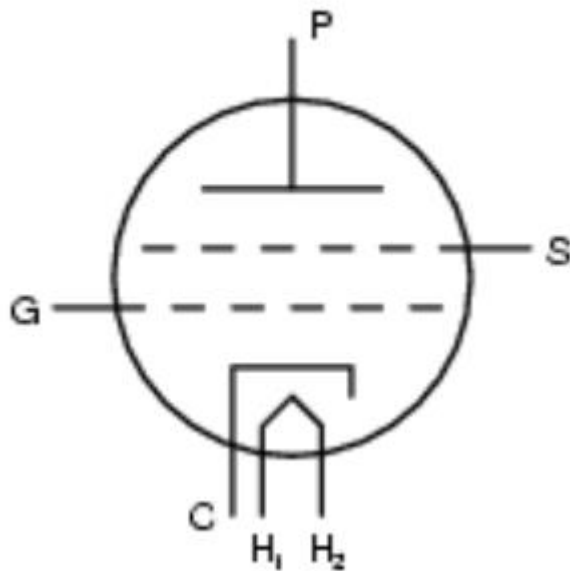

P = Plate
 S = Screen
 G = Grid
 C = Cathode
 H = Heater Element

Question File: 12. Device recognition: (1 question)

1. In the figure shown, 2 represents the:

- a. collector of a pnp transistor
- b. emitter of an npn transistor
- c. base of an npn transistor
- d. source of a junction FET



2. In the figure shown, 3 represents the:

- a. drain of a junction FET
- b. collector of an npn transistor
- c. emitter of a pnp transistor
- d. base of an npn transistor



3. In the figure shown, 2 represents the:

- a. **base of a pnp transistor**
- b. drain of a junction FET
- c. gate of a junction FET
- d. emitter of a pnp transistor



4. In the figure shown, 1 represents the:

- a. collector of a pnp transistor
- b. gate of a junction FET
- c. source of a MOSFET
- d. **emitter of a pnp transistor**



5. In the figure shown, 2 represents the:

- a. drain of a p-channel junction FET
- b. collector of an npn transistor
- c. **gate of an n-channel junction FET**
- d. base of a pnp transistor

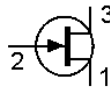

6. In the figure shown, 3 represents the:

- a. source of an n-channel junction FET
- b. gate of a p-channel junction FET
- c. emitter of a pnp transistor
- d. **drain of an n-channel junction FET**

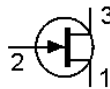

7. In the figure shown, 2 represents the:

- a. **gate of a MOSFET**
- b. base of a dual bipolar transistor
- c. anode of a silicon controlled rectifier
- d. cathode of a dual diode

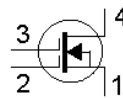

8. The figure shown represents a:

- a. dual bipolar transistor
- b. dual diode
- c. dual varactor diode
- d. **dual gate MOSFET**

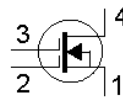

9. In the figure shown, 3 represents the:

- a. filament of a tetrode
- b. anode of a triode
- c. **grid of a tetrode**
- d. screen grid of a pentode

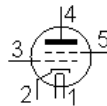

10. In the figure shown, 5 represents the:
- a. grid of a tetrode
 - b. screen grid of a tetrode
 - c. heater of a pentode
 - d. grid of a triode

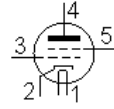

=====

Section 13 - Meters and Measuring

Ammeters.

- Have low internal resistance
- Placed in series with the item under test
- Displays the current traveling through the meter
- May short circuit if placed across a circuit by accident.

Voltmeters

- Have high internal resistance
- Placed across the item under test
- Displays the potential difference (voltage) between the 2 points of test
- Will not operate accurately if placed in series by accident.

Thus

When measuring the current drawn by a receiver from a power supply the meter should be placed in series with one of the power leads.

An Ammeter circuit measures current, it is in series and should have low internal resistance. This could be used to measure the supply current to an amplifier.

A voltmeter circuit should be in parallel and should have high resistance (ie, high ohms).

A DC ammeter could be used to measure power supply output current.

Do not put an ammeter over the car battery because it will cause a short circuit..

When measuring current in a light bulb from a dc supply meter it acts in the circuit as a very low value series resistance.

VSWR (voltage standing wave ratio) in reverse = relative reflected voltage.

AC voltmeter (RMS reading volt meter) is used to measure 50Hz sign wave of known peak voltage of 1 volts, the meter reading will be 0.707 volts.

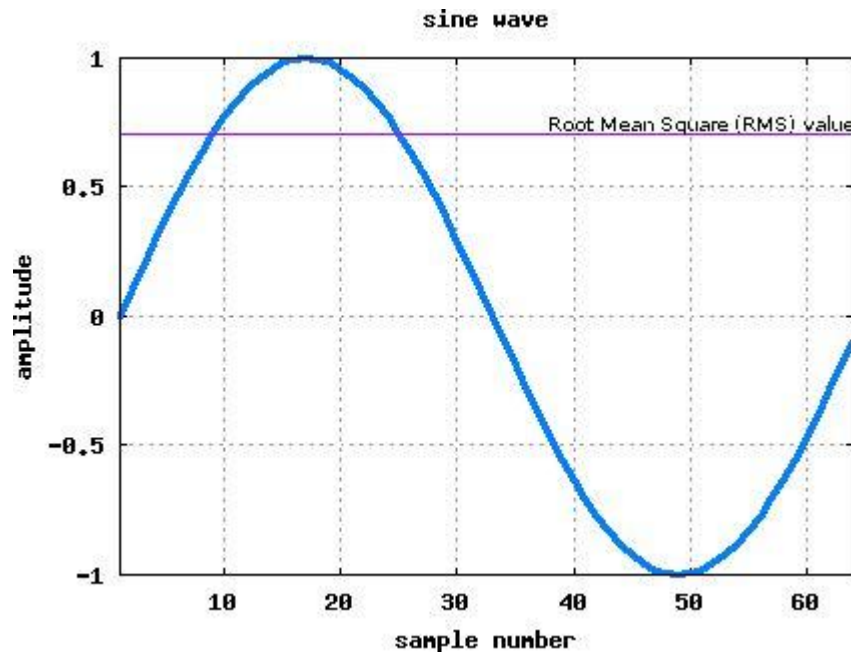

True RMS = 0.707 x peak voltage in a sinusoidal wave
 RMS < Peak voltage

An ohmmeter measures the value of any resistance placed between its terminals

Question File: 13. Meters and Measuring: (1 question)

1. An ohmmeter measures the:
 - a. value of any resistance placed between its terminals
 - b. impedance of any component placed between its terminals
 - c. power factor of any inductor or capacitor placed between its terminals
 - d. voltage across any resistance placed between its terminals

=====
2. A VSWR meter switched to the "reverse" position provides an indication of:
 - a. power output in watts
 - b. relative reflected voltage
 - c. relative forward voltage
 - d. reflected power in dB

=====
3. The correct instrument for measuring the supply current to an amplifier is a:
 - a. wattmeter
 - b. voltmeter
 - c. ammeter
 - d. ohmmeter

=====

4. The following meter could be used to measure the power supply current drawn by a small hand-held transistorised receiver:
- a power meter
 - an RF ammeter
 - a DC ammeter**
 - an electrostatic voltmeter
- =====
5. When measuring the current drawn by a light bulb from a DC supply, the meter will act in circuit as:
- an insulator
 - a low value resistance**
 - a perfect conductor
 - an extra current drain
- =====
6. When measuring the current drawn by a receiver from a power supply, the current meter should be placed:
- in parallel with both receiver power supply leads
 - in parallel with one of the receiver power leads
 - in series with both receiver power leads
 - in series with one of the receiver power leads**
- =====
7. An ammeter should not be connected directly across the terminals of a 12 volt car battery because:
- the resulting high current will probably destroy the ammeter**
 - no current will flow because no other components are in the circuit
 - the battery voltage will be too low for a measurable current to flow
 - the battery voltage will be too high for a measurable current to flow
- =====
8. A good ammeter should have:
- a very high internal resistance
 - a resistance equal to that of all other components in the circuit
 - a very low internal resistance**
 - an infinite resistance
- =====
9. A good voltmeter should have:
- a very high internal resistance**
 - a resistance equal to that of all other components in the circuit
 - a very low internal resistance
 - an inductive reactance
- =====
10. An rms-reading voltmeter is used to measure a 50 Hz sinewave of known peak voltage 14 volt. The meter reading will be about:
- 14 volt
 - 28 volt
 - 10 volt**
 - 50 volt
- =====

Section 14 - Decibels

For POWER

3dB = Double
10dB = X10

Therefore 20dB = x 100 (10dB + 10dB = 20dB, x10 x10 = x100)
 And 23dB = x 200 (10dB + 10 dB + 3dB = 23dB, x10 x10 x2 = x200)

For VOLTAGE

6dB = x 2
20dB = x 10

remember – dBs **add** together – where cascading amplifiers multiply

eg.

3 amplifiers have 4 x power gain connected in cascade (one after the other in series)

each amp has 6dB gain (x4 = 2 lots of x2, thus 2 lots of 3dB = 6dB)

for 3 amps just add each of the dB's together

so 3 lots of 6dB's = 18dB gain

eg2

a 10dB amplifier is connected in cascade with a 3dB attenuator. Calculate the overall gain.

10dB – 3dB = 7dB (minus for attenuation)

Question File: 14. Decibels, Amplification and Attenuation: (1 question)

1. The input to an amplifier is 1 volt rms and the output 10 volt rms. This is an increase of:
- 3 dB
 - 6 dB
 - 10 dB
 - 20 dB**
- =====
2. The input to an amplifier is 1 volt rms and output 100 volt rms. This is an increase of:
- 10 dB
 - 20 dB
 - 40 dB**
 - 100 dB
- =====
3. An amplifier has a gain of 40 dB. The ratio of the rms output voltage to the rms input voltage is:
- 20
 - 40
 - 100**
 - 400
- =====
4. A transmitter power amplifier has a gain of 20 dB. The ratio of the output power to the input power is:
- 10
 - 20
 - 40
 - 100**
- =====
5. An attenuator network comprises two 100 ohm resistors in series with the input applied across both resistors and the output taken from across one of them. The voltage attenuation of the network is:
- 3 dB
 - 6 dB**
 - 50 dB
 - 100 dB
- =====
6. An attenuator network has 10 volt rms applied to its input with 1 volt rms measured at its output. The attenuation of the network is:
- 6 dB
 - 10 dB
 - 20 dB**
 - 40 dB
- =====

7. An attenuator network has 10 volt rms applied to its input with 5 volt rms measured at its output. The attenuation of the network is:
- a. 6 dB
 - b. 10 dB
 - c. 20 dB
 - d. 40 dB
- =====
8. Two amplifiers with gains of 10 dB and 40 dB are connected in cascade. The gain of the combination is:
- a. 8 dB
 - b. 30 dB
 - c. 50 dB
 - d. 400 dB
- =====
9. An amplifier with a gain of 20 dB has a -10 dB attenuator connected in cascade. The gain of the combination is:
- a. 8 dB
 - b. 10 dB
 - c. -10 dB
 - d. -200 dB
- =====
10. Each stage of a three-stage amplifier provides 5 dB gain. The total amplification is:
- a. 10 dB
 - b. 15 dB
 - c. 25 dB
 - d. 125 dB
- =====

Section 15 Station Components

Amateur radio stations range from the very simple to the very elaborate and complex. Some of the common elements are considered here. This block diagram is typical of the High Frequency equipment used in an amateur station.

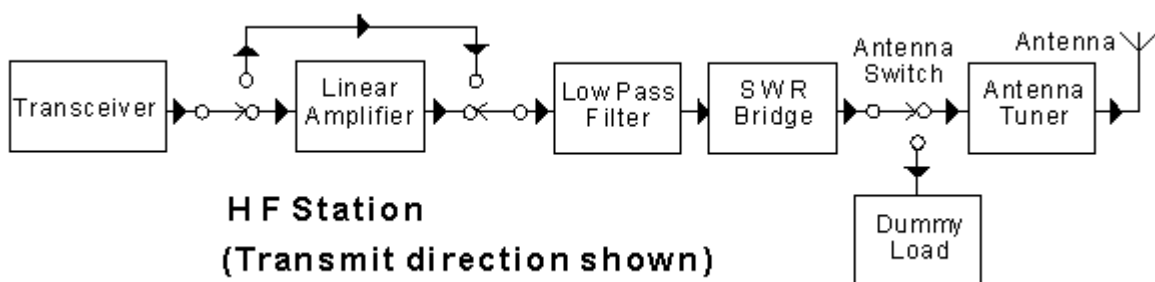
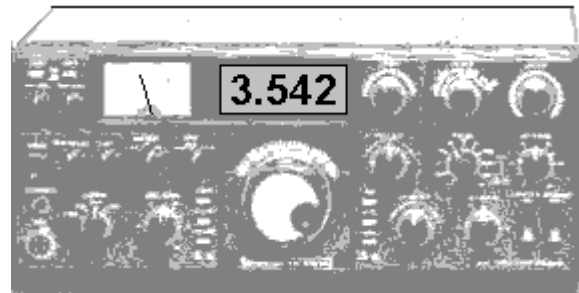

The Transceiver

This is the centre-piece of the station and where most things happen! It contains both transmitter and receiver. These functions are treated elsewhere in this Study Guide.

The Linear Amplifier

This is switched in to provide a stronger transmitted signal at times of difficult conditions. Not an essential item and not all radio amateurs use them or find them to be necessary. It provides an amplified version of the signal fed into its input. The term "linear" means that the output signal is a replica of the waveform of the signal fed into its input - except that the amplitude of it is greater.

The Low Pass Filter

This device is designed to prevent the passing of frequencies above 30 MHz (the limit of HF and where VHF begins) from the transmitter to the antenna. It is good practice to have this item in use but it may not always be required. Many modern transceivers are already fitted with such a filter.

S W R Bridge

This little box (**S**tanding **W**ave **R**atio bridge - or meter) does two things. It gives a measure of the transmitter output power level. It also gives an indication of how well the antenna is working. If the feeder to the antenna is damaged or the antenna itself is faulty, a glance at this meter will indicate a problem.

The Antenna Switch

Only two positions are shown in this diagram. The switch changes between the external antenna and the "dummy load" (used for testing). In practice, the Antenna Switch may have many positions and be used for selecting between various antennas as well as the dummy load. It is general practice to use a multi-element beam antenna for operating at 14 MHz and above, and to use a "wire antenna" on frequencies below 14 MHz, but there are no hard and fast rules!

The Antenna Tuner

This name is not strictly correct. This device takes the impedance "seen looking down the antenna feedline" and corrects it for correct "match" to the output impedance of the transmitter. This device is treated elsewhere in this Study

The Dummy Antenna (Dummy Load)

The purpose of this device is to allow you to carry out adjustments to your transmitter without actually transmitting a signal on the air. It is usually a collection of carbon resistors in a can - for shielding. The can may be filled with transformer oil to assist cooling.

It is important to know the power rating for your dummy load. The time that you can use it with a high-power signal may be very short before overheating causes it to be severely damaged. Know your ratings and observe them!

The Dummy Antenna should be connected to your antenna switch as one of your antennas. The device simulates an antenna in all respects except that it does not radiate. It usually has a 50 ohm impedance



Transmitter off

with a low SWR of 1 to 1.

A practical unit

Sometimes an SWR Bridge, an Antenna Tuner, Antenna Switch and a Dummy Load, are all combined into the one box.

Sometimes the two SWR meters are built into one instrument - with cross-needles. The crossing point of the two needles can be read directly as the SWR value off a separate scale on the face of the meter, while each separate needle indicates the forward and reflected power on its own arc-scale. An example is in the photograph.

Question File: 15. HF Station Arrangement: (1 question)

1. In the block diagram shown, the "linear amplifier" is:

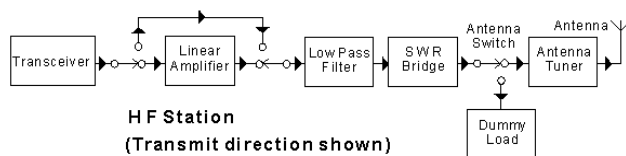

- an amplifier to remove distortion in signals from the transceiver
- an optional amplifier to be switched in when higher power is required
- an amplifier with all components arranged in-line
- a push-pull amplifier to cancel second harmonic distortion

2. In the block diagram shown, the additional signal path above the "linear amplifier" block indicates that:

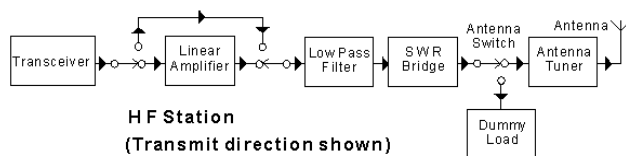

- some power is passed around the linear amplifier for stability
- "feed-forward" correction is being used to increase linearity
- the linear amplifier input and output terminals may be short-circuited
- the linear amplifier may be optionally switched out of circuit to reduce output power

3. In the block diagram shown, the "low pass filter" must be rated to:

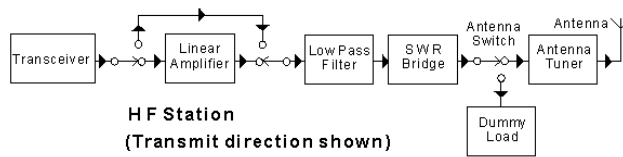

- carry the full power output from the station
- filter out higher-frequency modulation components for maximum intelligibility
- filter out high-amplitude sideband components
- emphasise low-speed Morse code output

4. In the block diagram shown, the "SWR bridge" is a:

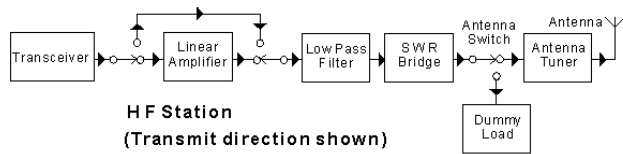

- switched wave rectifier for monitoring power output
- static wave reducer to minimize static electricity from the antenna
- device to monitor the standing-wave-ratio on the antenna feedline
- short wave rectifier to protect against lightning strikes

5. In the block diagram shown, the "antenna switch":

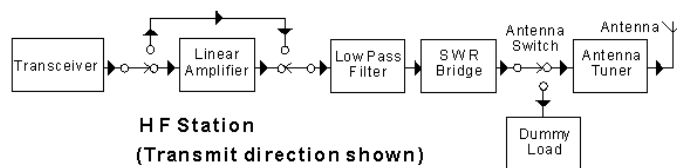

- switches the transmitter output to the dummy load for tune-up purposes
- switches the antenna from transmit to receive
- switches the frequency of the antenna for operation on different bands
- switches surplus output power from the antenna to the dummy load to avoid distortion.

6. In the block diagram shown, the "antenna tuner":

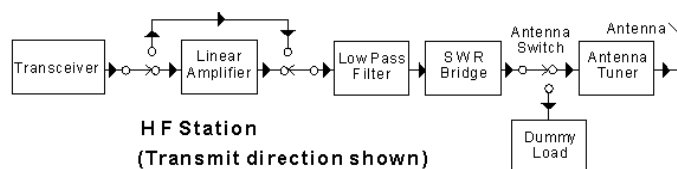

- adjusts the resonant frequency of the antenna to minimize harmonic radiation
- adjusts the resonant frequency of the antenna to maximise power output
- changes the standing-wave-ratio on the transmission line to the antenna
- adjusts the impedance of the antenna system seen at the transceiver output

7. In the block diagram shown, the "dummy load" is:

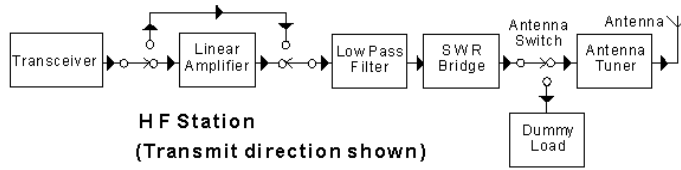

- a. used to allow adjustment of the transmitter without causing interference to others
- b. a load used to absorb surplus power which is rejected by the antenna system
- c. used to absorb high-voltage impulses caused by lightning strikes to the antenna
- d. an additional load used to compensate for a badly-tuned antenna system

8. In the block diagram shown, the connection between the SWR bridge and the antenna switch is normally a:

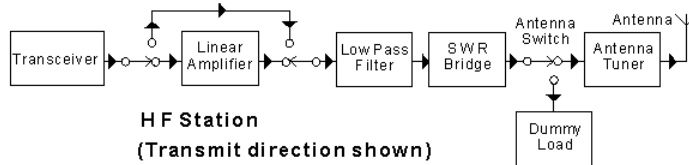

- a. twisted pair cable
- b. coaxial cable
- c. quarter-wave matching section
- d. short length of balanced ladder-line

9. In this block diagram, the block designated "antenna tuner" is not normally necessary when:

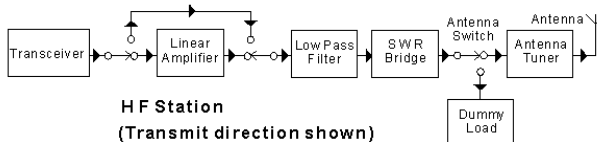

- a. the antenna input impedance is 50 ohms
- b. a half wave antenna is used, fed at one end
- c. the antenna is very long compared to a wavelength
- d. the antenna is very short compared to a wavelength

10. In the block diagram shown, the connection between the "antenna tuner" and the "antenna" could be made with:

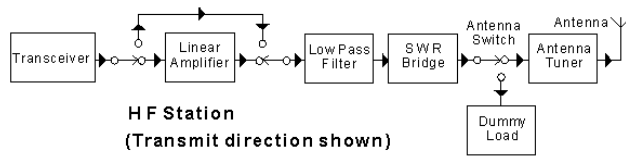

- a. three-wire mains power cable
 - b. heavy hook-up wire
 - c. 50 ohm coaxial cable
 - d. an iron-cored transformer
- =====

Section 16 Receiver Block Diagrams

How to draw them!

This is a "block diagram" of a "super-heterodyne" receiver. Before the actual stages are discussed, consider the diagram itself. It is drawn to show the "signal flow" entirely from **left to right**, shown by the arrows.

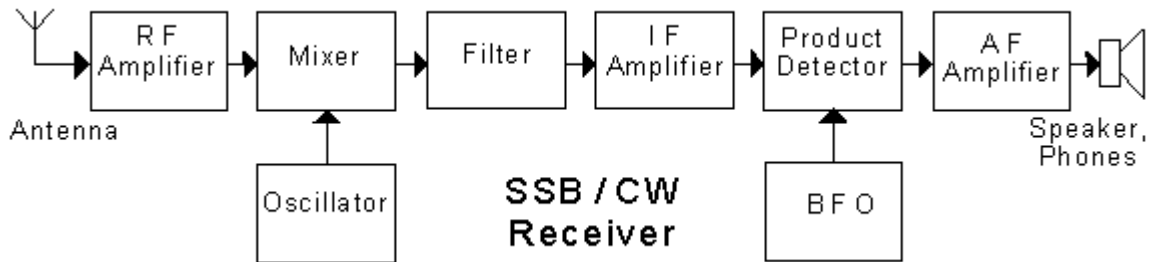

It starts with the antenna (aerial) on the left. The signal flows through many stages, shown by arrows from *left to right*. It ends with the speaker (or phones) on the right.

The "superhet" receiver

The diagram shows a "super-sonic heterodyne" - or "superhet" - receiver, the standard pattern for receivers in general use today. The first thing to note is that **three** amplifiers are shown, the RF amplifier, the IF amplifier, and the AF amplifier. Let's look at each in turn.

The Radio Frequency amplifier

This provides amplification for the signal as soon as it arrives from the antenna. The amplified signal is then passed to the "mixer/oscillator". The purpose of the mixer/oscillator is to translate the frequency of the incoming signal to the "intermediate frequency", i.e. to the "IF amplifier".

The mixer stage is usually acknowledged as being the noisiest stage in the receiver so an RF amplifier is positioned ahead of it to mask that noise with a higher signal level.

The RF amplifier stage should use a low-noise amplifying device - such as a low-noise transistor - to keep the internally-generated noise of the receiver to as low as possible. All the following amplifying stages will amplify this RF stage noise as well as the signal, so a low-noise device at the start of the receiving process is very important.

The Intermediate Frequency amplifier

It is in the IF amplifier **where most of the amplification in a receiver takes place**. Sometimes there may be two or more stages of IF amplification. The "IF frequency" is carefully selected,

but more about that below. The filter block prior to the amplifier shapes the "passband" of the receiver.

The filter pass-band should be tailored to fit the signal being received - in the interests of keeping out unwanted noise and unwanted signals. A 500 Hz pass-band for CW reception, a 3 kHz pass-band for SSB, and 6 kHz for AM, would be typical.

From the IF stages, the signal passes to a detector. Here demodulation of the radio-frequency signal takes place to produce an audio signal.

The diagram shows a "product detector" with a Beat Frequency Oscillator - or Carrier Insertion Oscillator (CIO) - for SSB and CW reception.

The Audio Frequency amplifier

Finally the audio signal is amplified in the audio amplifier and passed on to a speaker or phones for the listener to enjoy.

Receiving a signal

The superhet receiver is really in two parts:

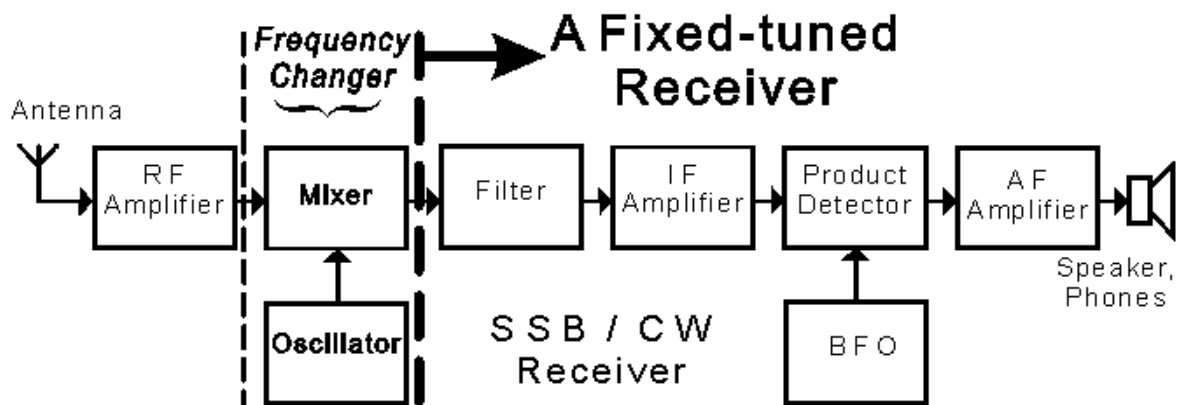

1. From IF amplifier onwards, it is a "**fixed frequency receiver**", a receiver pre-tuned and optimised for the reception of a signal on the IF frequency.
2. The RF amplifier and mixer/oscillator receive signals from the antenna and then convert them to the frequency of this optimum receiver - to the IF frequency. It is in the RF amplifier and mixer/oscillator sections of the receiver where the actual operator adjustment and tuning for the selection or "**choice of received signal**" takes place.

Tuning a Superhet Receiver

To change the frequency of the incoming signal to the IF frequency, the tuned circuits in the RF amplifier, the mixer input, and the local oscillator, must be adjustable from the front panel. A

look inside a typical conventional superhet receiver cabinet may disclose a "three-gang" tuning capacitor. Each "section" of this component tunes part of the first stages of the receiver. Note that it is the INPUT to the mixer which is tuned by a variable capacitor - the output is fixed-tuned at the IF frequency.

The choice of Intermediate Frequency

There are two conflicts with the choice of the IF Frequency:

A **low intermediate frequency** brings the advantage of higher stage gain and higher selectivity using high-Q tuned circuits. Sharp pass-bands are possible for narrow-band working for CW and SSB reception.

A **high intermediate frequency** brings the advantage of a lower **image** response.

The "image frequency" problem can be seen in this example:

Consider a receiver for 10 MHz using an IF frequency of 100 kHz. The local oscillator will be on either 10.1 MHz - i.e. 100 kHz higher than the required input signal - or on 9.9 MHz. We will consider the 10.1 MHz case - but the principles are the same for the case where the oscillator is LOWER in frequency than the wanted signal frequency. .

Because of the way that mixers work, a signal at 10.2 MHz will also be received. This is known as the IMAGE frequency.

The image rejection of a superhet receiver can be improved by having more tuned circuits set to the required input frequency, such as more tuned circuits in the RF amplifier ahead of the mixer. This brings practical construction difficulties.

Another solution is to choose a high IF frequency so that the

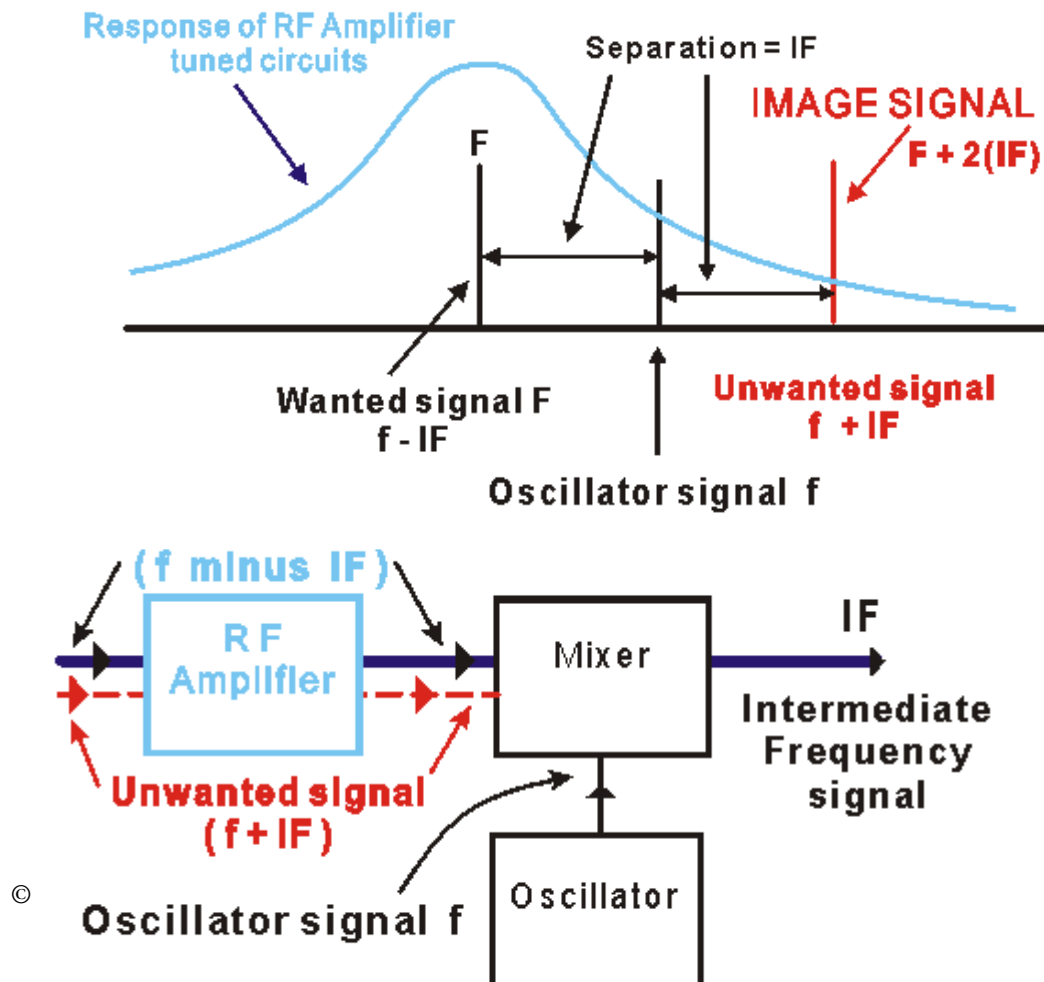

required received frequency and the image frequency are well separated in frequency. Choosing an IF of 2 MHz for the 10 MHz receiver would put the local oscillator at 12 MHz, the image frequency then being at 14 MHz.

When receiving a signal at 10 MHz, it is easier to reject a signal at 14 MHz (the image in the 2 MHz IF case) than at 10.2 MHz (the image in the 100kHz IF case).

Note that the Image Frequency is **TWICE** the IF Frequency removed from the **WANTED** signal frequency - on the same side of the wanted frequency as the oscillator.

The "Double Conversion" receiver

The "double-conversion" superhet receiver brings the good points from both IF choices. A high frequency IF is first chosen to bring a satisfactory image response, followed by a low-frequency IF to bring high selectivity and gain.

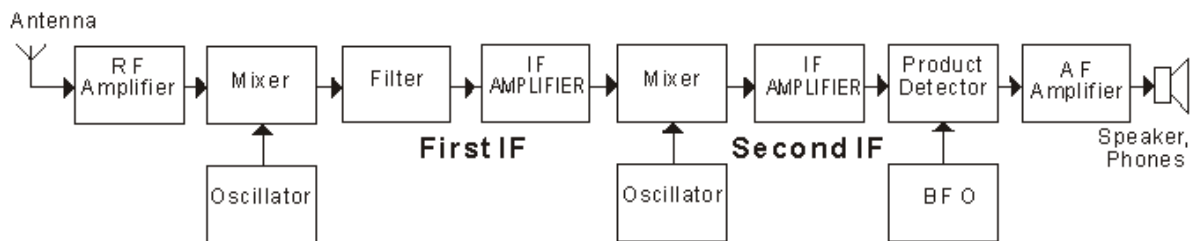

Double Conversion Receiver

Typical examples would be a 5 MHz first IF and a 100 kHz second IF - but many designs are possible. There may be front-panel-selectable quartz or mechanical filters used at either or both IF's to give added selectivity.

The only two disadvantages of the double-conversion receiver are the added complexity and the additional oscillators required. These oscillators, unless carefully shielded, can mix with each other and produce unwanted signals at spots throughout the spectrum.

Count up the number of oscillators involved - including the BFO / CIO.

The F M Receiver

A receiver for FM signals follows the same general principles as a receiver for CW and SSB reception.

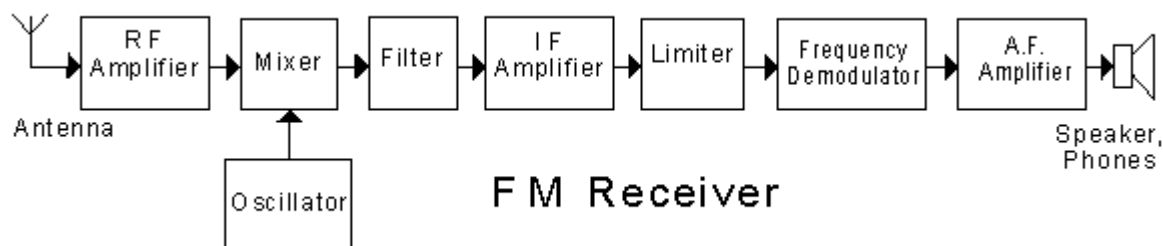

The frequency coverage for an FM receiver is different to that of a SSB / CW receiver. FM is a distinct VHF-and-higher mode. So FM receivers are for VHF and higher reception. In hand-held transceivers, the receiver will be "channelised" for switch-channel reception.

The IF amplifier is much wider in bandwidth than that of a CW/SSB receiver. So the IF amplifier will be higher in frequency - (say) 10.7 MHz.

The demodulator will usually be a "discriminator" and may even be of a "phase-lock-loop" variety. There will be a "limiter" before the discriminator to remove noise peaks and amplitude-changes before detection of the FM signal



Question File: 16. Receiver Block Diagrams: (2 questions)

1. In the block diagram of the receiver shown, the "RF amplifier":

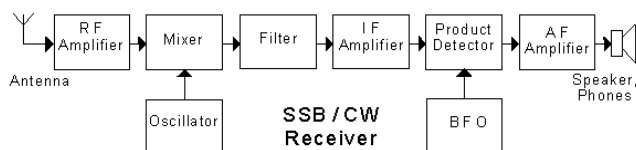

- decreases random fluctuation noise
- is a restoring filter amplifier
- increases the incoming signal level
- changes the signal frequency

2. In the block diagram of the receiver shown, the "mixer":

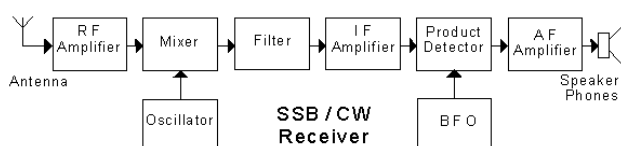

- combines signals at two different frequencies to produce one at an intermediate frequency
- combines sidebands to produce a stronger signal
- discriminates against SSB and AM signals
- inserts a carrier wave to produce a true FM signal

3. In the block diagram of the receiver shown, the output frequency of the "oscillator" is:

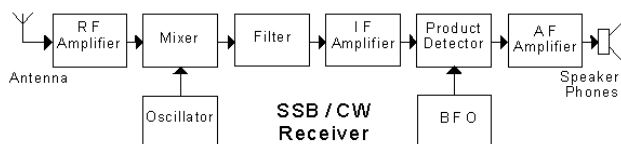

- the same as that of the incoming received signal
- the same as that of the IF frequency
- different from both the incoming signal and IF frequencies
- at a low audio frequency

4. In the block diagram of the receiver shown, the "filter" rejects:

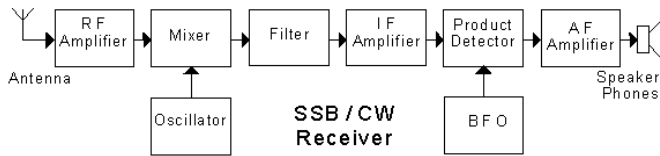

- AM and RTTY signals
- unwanted mixer outputs
- noise bursts
- broadcast band signals

5. In the block diagram of the receiver shown, the "IF amplifier" is an:

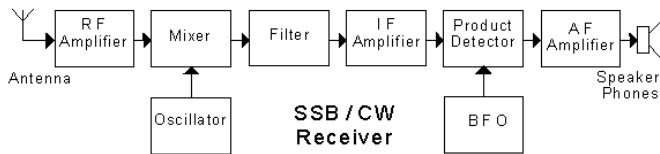

- isolation frequency amplifier
- intelligence frequency amplifier
- indeterminate frequency amplifier
- intermediate frequency amplifier

6. In the block diagram of the receiver shown, the "product detector":

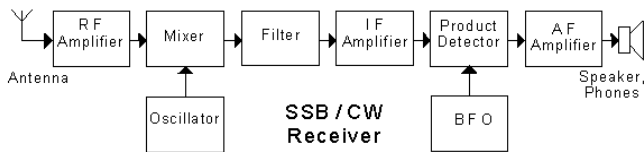

- produces an 800 Hz beat note
- separates CW and SSB signals
- rejects AM signals
- translates signals to audio frequencies

7. In the block diagram of the receiver shown, the "AF amplifier":

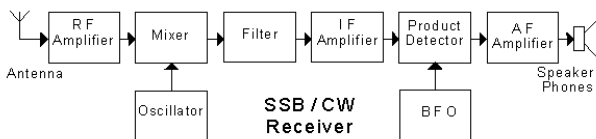

- rejects AM and RTTY signals
- amplifies audio frequency signals
- has a very narrow passband
- restores ambiance to the audio

8. In the block diagram of the receiver shown, the "BFO" stands for:

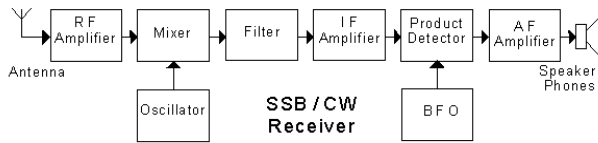

- bad frequency obscurer
- basic frequency oscillator
- beat frequency oscillator
- band filter oscillator

9. In the block diagram of the receiver shown, most of the receiver gain is in the:

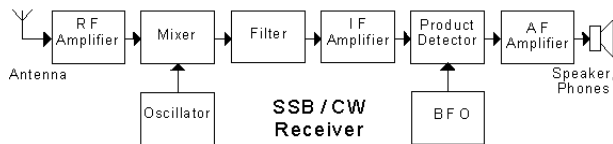

- RF amplifier
- IF amplifier
- AF amplifier
- mixer

10. In the block diagram of the receiver shown, the "RF amplifier":

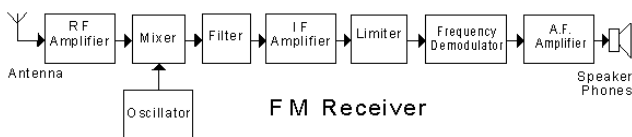

- decreases random fluctuation noise
- masks strong noise
- should produce little internal noise
- changes the signal frequency

11. In the block diagram of the receiver shown, the "mixer":

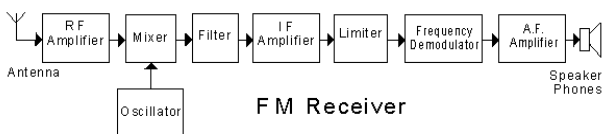

- changes the signal frequency
- rejects SSB and CW signals
- protects against receiver overload
- limits the noise on the signal

12.. In the receiver shown, when receiving a signal, the output frequency of the "oscillator" is:

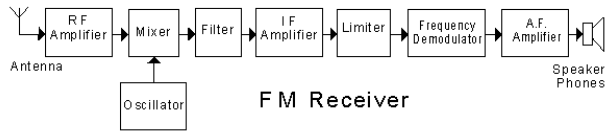

- the same as that of the signal
- the same as that of the IF amplifier
- of constant amplitude and frequency
- passed through the following filter

13. In the block diagram of the receiver shown, the "limiter":

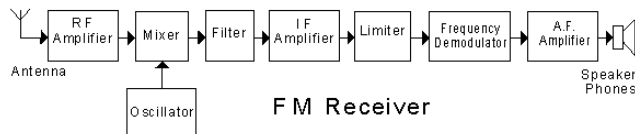

- limits the signal to a constant amplitude
- rejects SSB and CW signals
- limits the frequency shift of the signal
- limits the phase shift of the signal

14. In the block diagram of the receiver shown, the "frequency demodulator" could be implemented with a:

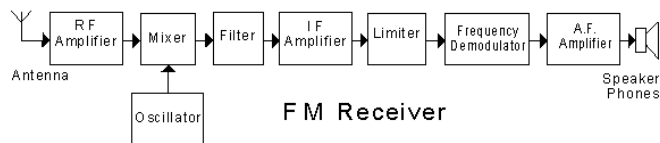

- product detector
- phase-locked loop
- full-wave rectifier
- low-pass filter

15 In the block diagram of the receiver shown, the "AF amplifier":

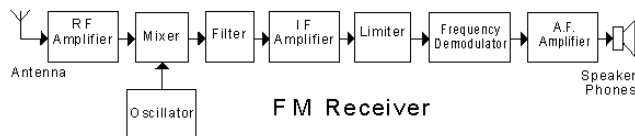

- amplifies stereo signals
- amplifies speech frequencies
- is an all frequency amplifier
- must be fitted with a tone control

16. In this receiver, an audio frequency gain control would be associated with the block labelled:

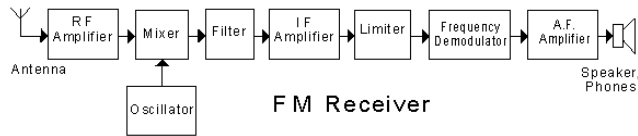

- a. AF amplifier
 b. frequency demodulator
 c. speaker, phones
 d. IF amplifier

17. In the block diagram of the receiver shown, the selectivity would be set by the:

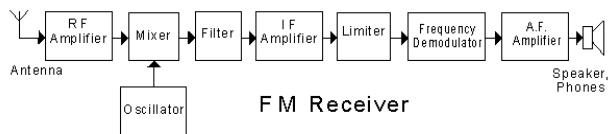

- a. AF amplifier
 b. mixer
 c. limiter
 d. filter

18. In the FM communications receiver shown in the block diagram, the "filter" bandwidth is typically:

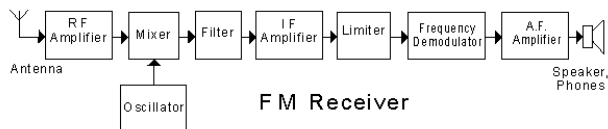

- a. 3 kHz
 b. 10 kHz
 c. 64 kHz
 d. 128 kHz

19. In the block diagram of the receiver shown, an automatic gain control (AGC) circuit would be associated with the:

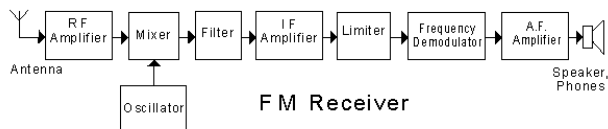

- a. speaker
 b. IF amplifier
 c. RF filter
 d. oscillator

20. In the block diagram of the receiver shown, the waveform produced by the "oscillator" would ideally be a:

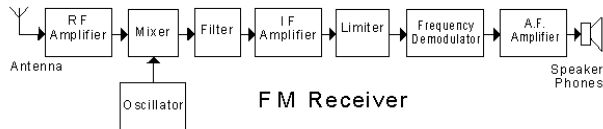

- a. square wave
 - b. pulsed wave
 - c. **sinewave**
 - d. hybrid frequency wave
- =====

Section 17 Receiver fundamentals

Here we look at typical specifications for receivers and at some of the features found to improve operating convenience.

Frequency stability

The ability of a receiver to stay tuned to an incoming signal for a long period is related to the frequency stability of its local oscillator. This same requirement applies to transmitters.

Metal shielding is used around oscillator coils and the components used may be especially selected for high frequency stability.

Sensitivity

The sensitivity of a receiver is its ability to receive weak signals. Selectivity is more important than sensitivity.

Noise

The first stage in the receiving block-diagram chain, the RF amplifier, sets the noise characteristics for a receiver. The RF amplifier should use a low-noise device and it should generate very little internal noise. Measurement of sensitivity requires test equipment, equipment able to measure the "signal plus noise" audio output from the receiver and the "noise alone" with no signal being received.

The ratio: $(S+N)/N$ (i.e. signal plus noise to noise) is often used with this test for comparing receivers.

There is far more to measuring the sensitivity and other characteristics of a receiver than is often realised! Please refer to standard textbooks on the subject.

Selectivity

The ability to separate two closely spaced signals is a receiver's "selectivity". The characteristics of the filter in the IF amplifier determine the frequency response of the IF stages and the "selectivity".

The narrower the filter pass-band, the "higher" the selectivity.

The receiver pass-band should be tailored to the characteristics of the incoming signal. Too wide a pass-band and unwanted noise is received which detracts from the reception of the wanted signal.

We use **bandwidth** to measure selectivity. This is how wide a range of frequencies you hear with the receiver tuned to a set frequency. Filters can often be selected by a front-panel switch to provide different receiver bandwidth characteristics.

The audio stage

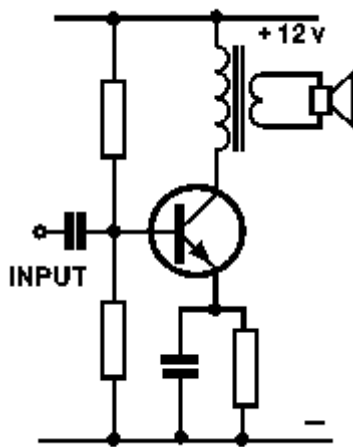

low audio output.

The audio stage of a receiver amplifies the signal from the detector and raises it to a level suitable for driving headphones or a speaker.

A typical speaker is a load impedance of about 8 ohm. A transformer is generally used to match this low-impedance load to the impedance level required for the best performance of the amplifier.

There are many types of audio amplifier. The circuit shown here is to show the principles. It is typical of that in a very simple radio - with a small speaker and

Question File: 17. Receiver Operation: (3 questions)

1. The frequency stability of a receiver is its ability to:
 - a. stay tuned to the desired signal
 - b. track the incoming signal as it drifts
 - c. provide a frequency standard
 - d. provide a digital readout

=====
2. The sensitivity of a receiver specifies:
 - a. the bandwidth of the RF preamplifier
 - b. the stability of the oscillator
 - c. its ability to receive weak signals
 - d. its ability to reject strong signals

=====
3. Of two receivers, the one capable of receiving the weakest signal will have:
 - a. an RF gain control
 - b. the least internally-generated noise
 - c. the loudest audio output
 - d. the greatest tuning range

=====
4. The figure in a receiver's specifications which indicates its sensitivity is the:
 - a. bandwidth of the IF in kilohertz
 - b. audio output in watts
 - c. signal plus noise to noise ratio
 - d. number of RF amplifiers

=====

5. If two receivers are compared, the more sensitive receiver will produce:
- more than one signal
 - less signal and more noise
 - more signal and less noise
 - a steady oscillator drift
- =====
6. The ability of a receiver to separate signals close in frequency is called its:
- noise figure
 - sensitivity
 - bandwidth
 - selectivity
- =====
7. A receiver with high selectivity has a:
- wide bandwidth
 - wide tuning range
 - narrow bandwidth
 - narrow tuning range
- =====
8. The BFO in a superhet receiver operates on a frequency nearest to that of its:
- RF amplifier
 - audio amplifier
 - local oscillator
 - IF amplifier
- =====
9. To receive Morse code signals, a BFO is employed in a superhet receiver to:
- produce IF signals
 - beat with the local oscillator signal to produce sidebands
 - produce an audio tone to beat with the IF signal
 - beat with the IF signal to produce an audio tone
- =====
10. The following transmission mode is usually demodulated by a product detector:
- pulse modulation
 - double sideband full carrier modulation
 - frequency modulation
 - single sideband suppressed carrier modulation
- =====
11. A superhet receiver for SSB reception has an insertion oscillator to:
- replace the suppressed carrier for detection
 - phase out the unwanted sideband signal
 - reduce the passband of the IF stages
 - beat with the received carrier to produce the other sideband
- =====

12. A stage in a receiver with input and output circuits tuned to the received frequency is the:
- a. RF amplifier
 - b. local oscillator
 - c. audio frequency amplifier
 - d. detector
- =====
13. An RF amplifier ahead of the mixer stage in a superhet receiver:
- a. enables the receiver to tune a greater frequency range
 - b. means no BFO stage is needed
 - c. makes it possible to receive SSB signals
 - d. increases the sensitivity of the receiver
- =====
14. A communication receiver may have several IF filters of different bandwidths. The operator selects one to:
- a. improve the S-meter readings
 - b. improve the receiver sensitivity
 - c. improve the reception of different types of signal
 - d. increase the noise received
- =====
15. The stage in a superhet receiver with a tuneable input and fixed tuned output is the:
- a. RF amplifier
 - b. mixer stage
 - c. IF amplifier
 - d. local oscillator
- =====
16. The mixer stage of a superhet receiver:
- a. produces spurious signals
 - b. produces an intermediate frequency signal
 - c. acts as a buffer stage
 - d. demodulates SSB signals
- =====
17. A 7 MHz signal and a 16 MHz oscillator are applied to a mixer stage. The output will contain the input frequencies and:
- a. 8 and 9 MHz
 - b. 7 and 9 MHz
 - c. 9 and 23 MHz
 - d. 3.5 and 9 MHz
- =====
18. Selectivity in a superhet receiver is achieved primarily in the:
- a. RF amplifier
 - b. Mixer
 - c. IF amplifier
 - d. Audio stage
- =====

19. The abbreviation AGC means:
- attenuating gain capacitor
 - automatic gain control**
 - anode-grid capacitor
 - amplified grid conductance
- =====
20. The AGC circuit in a receiver usually controls the:
- audio stage
 - mixer stage
 - power supply
 - RF and IF stages**
- =====
21. The tuning control of a superhet receiver changes the tuned frequency of the:
- audio amplifier
 - IF amplifier
 - local oscillator**
 - post-detector amplifier
- =====
22. A superhet receiver, with an IF at 500 kHz, is receiving a 14 MHz signal. The local oscillator frequency is:
- 14.5 MHz**
 - 19 MHz
 - 500 kHz
 - 28 MHz
- =====
23. An audio amplifier is necessary in an AM receiver because:
- signals leaving the detector are weak**
 - the carrier frequency must be replaced
 - the signal requires demodulation
 - RF signals are not heard by the human ear
- =====
24. The audio output transformer in a receiver is required to:
- step up the audio gain
 - protect the loudspeaker from high currents
 - improve the audio tone
 - match the output impedance of the audio amplifier to the speaker**
- =====
25. If the carrier insertion oscillator is counted, then a single conversion superhet receiver has:
- one oscillator
 - two oscillators**
 - three oscillators
 - four oscillators
- =====

26. A superhet receiver, with a 500 kHz IF, is receiving a signal at 21.0 MHz. A strong unwanted signal at 22 MHz is interfering. The cause is:
- insufficient IF selectivity
 - the 22 MHz signal is out-of-band
 - 22 MHz is the image frequency
 - insufficient RF gain
- =====
27. A superhet receiver receives an incoming signal of 3540 kHz and the local oscillator produces a signal of 3995 kHz. The IF amplifier is tuned to:
- 455 kHz
 - 3540 kHz
 - 3995 kHz
 - 7435 kHz
- =====
28. A double conversion receiver designed for SSB reception has a carrier insertion oscillator and:
- one IF stage and one local oscillator
 - two IF stages and one local oscillator
 - two IF stages and two local oscillators
 - two IF stages and three local oscillators
- =====
29. An advantage of a double conversion receiver is that it:
- does not drift off frequency
 - produces a louder audio signal
 - has improved image rejection characteristics
 - is a more sensitive receiver
- =====
30. A receiver squelch circuit:
- automatically keeps the audio output at maximum level
 - silences the receiver speaker during periods of no received signal
 - provides a noisy operating environment
 - is not suitable for pocket-size receivers
- =====

Section 18 Transmitter Block Diagrams

How to draw them!

This is a "block diagram" of a simple transmitter. Before the actual stages are discussed, consider the diagram itself. It is drawn to show the "signal flow" entirely from **left to right**, shown by the arrows.

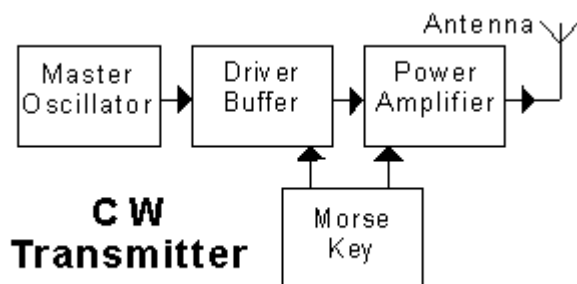

The CW Transmitter

The simplest of all transmitters is one for sending Morse code - a CW (Continuous Wave) transmitter as shown in the diagram above

An oscillator generates the signal and it is then amplified to raise the power output to the desired level. A Morse key is used to chop the transmission up into the "dots" and "dashes" of Morse code

The oscillator runs continuously. The Driver / Buffer are isolation stages, to isolate the oscillator from the sudden load-changes due to the keying of the amplifier. This minimises frequency "chirp" on the transmitted signal.

The oscillator is usually supplied with DC from a voltage-regulated source to minimise chirp (slight changes in the output frequency) due to variations in the supply voltage.

Several driver and buffer stages may be used. The keying may be in the final amplifier alone - usually in the cathode or emitter lead - or may also be applied to the driver stage too.

A "keying relay" may be used to isolate the Morse key from the transmitter circuits, to keep high voltages away from the operator's Morse key. In the interests of operator safety, the moving bar of the Morse key is **ALWAYS** kept at earth potential.

The AM Transmitter

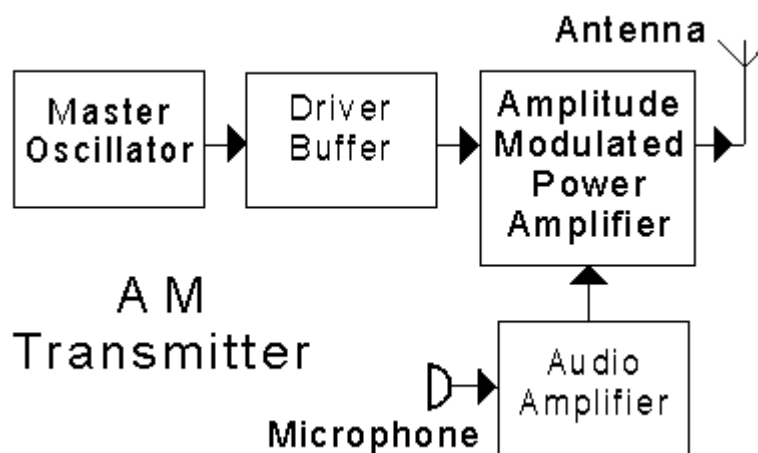

This is a diagram of a typical Amplitude-Modulated transmitter.

The block diagram is derived from the CW transmitter.

The modulated stage is usually the final amplifier in the transmitter. This is known as "high-level" modulation. If a following amplifier is used to raise the output power level, it must be a **linear** amplifier.

The SSB Transmitter

A transmitter takes the generated signal and first translates it with a mixer / VFO combination to the required output frequency then amplifies it to the required power output level using a **linear** amplifier. A linear amplifier is needed to preserve the signal waveform in all ways except to increase the output amplitude.

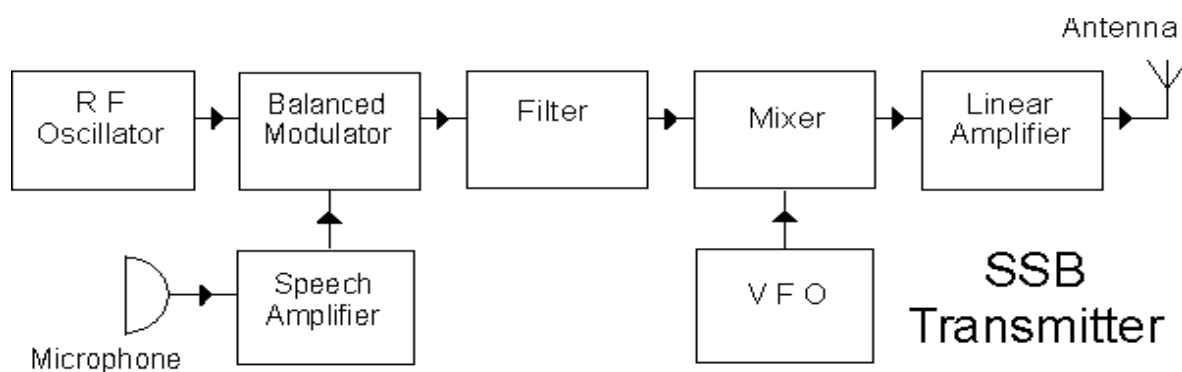

The F M transmitter

The modulator can be one of several types. The simplest to understand is probably to consider the voltage-controlled oscillator

Applying an audio signal to the varicap diodes in the circuit example given in the Oscillator discussion will change the frequency of the oscillator in accord with the modulation. This increases the frequency swing with increased audio loudness, and the rate of swing with increasing audio frequency - hence providing Frequency Modulation.

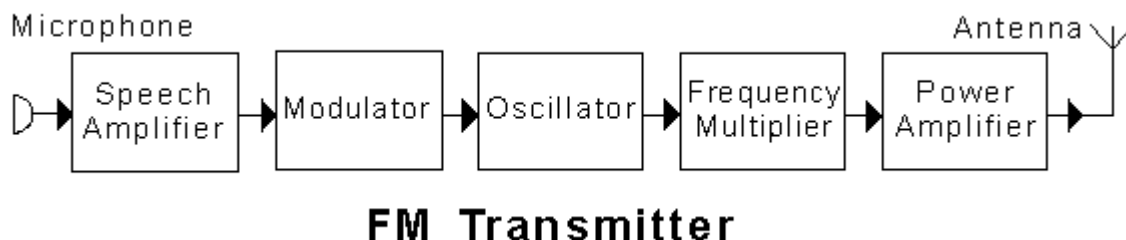

In VHF hand-held transceivers, the oscillator will be generated by a phase-locked-loop to get "channel switching" facilities. The frequency modulation may then be generated by applying the audio signal to the PLL.

The Frequency Multiplier stage is an RF amplifier with a tuned output - the output tuned to a harmonic of the input signal.

Question File: 18. Transmitter Block Diagrams: (2 questions)

1. In the transmitter block diagram shown, the "oscillator":

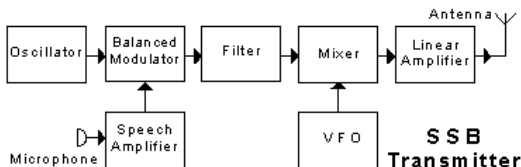

- is variable in frequency
- generates an audio frequency tone during tests
- uses a crystal for good frequency stability
- may have a calibrated dial

2. In the transmitter block diagram shown, the "balanced modulator":

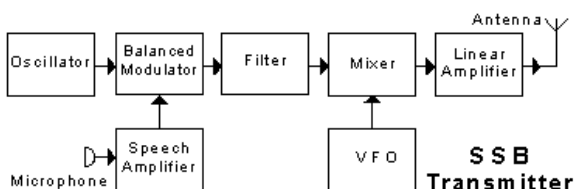

- balances the high and low frequencies in the audio signal
- performs double sideband suppressed carrier modulation
- acts as a tone control
- balances the standing wave ratio

3. In the transmitter block diagram shown, the "filter":

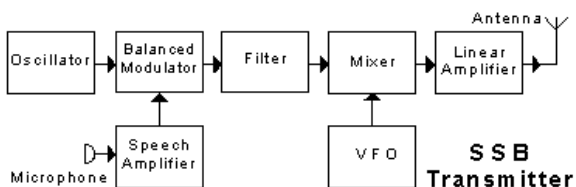

- removes mains hum from the audio signal
- suppresses unwanted harmonics of the RF signal
- removes one sideband from the modulated signal
- removes the carrier component from the modulated signal

4. In the transmitter block diagram shown, the "mixer":

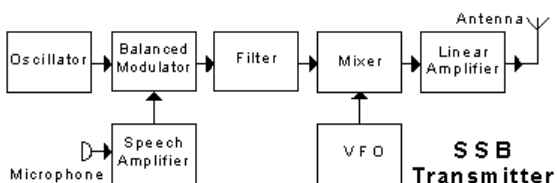

- adds the correct proportion of carrier to the SSB signal
- mixes the audio and RF signals in the correct proportions
- translates the SSB signal to the required frequency
- mixes the two sidebands in the correct proportions

5. In the transmitter block diagram shown, the "linear amplifier":

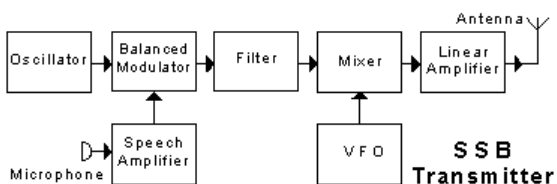

- has all components arranged in-line
- amplifies the modulated signal with no distortion
- aligns the two sidebands correctly
- removes any unwanted amplitude modulation from the signal

6. In the transmitter block diagram shown, the "VFO" is:

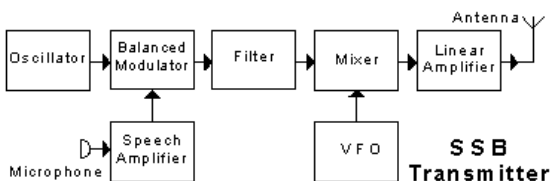

- a voice frequency oscillator
- a varactor fixed oscillator
- a virtual faze oscillator
- a variable frequency oscillator

7. In the transmitter block diagram shown, the "master oscillator" produces:

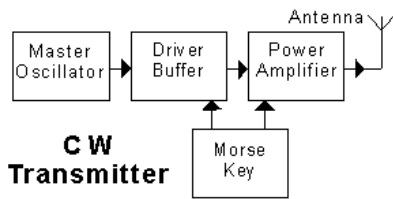

- a steady signal at the required carrier frequency
- a pulsating signal at the required carrier frequency
- a 800 Hz signal to modulate the carrier
- a modulated CW signal

8. In the transmitter block diagram shown, the "driver buffer":

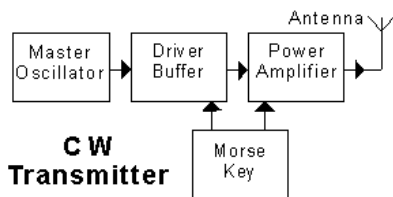

- filters any sharp edges from the input signal
- drives the power amplifier into saturation
- provides isolation between the oscillator and power amplifier
- changes the frequency of the master oscillator signal

9. In the transmitter block diagram shown, the "Morse key":

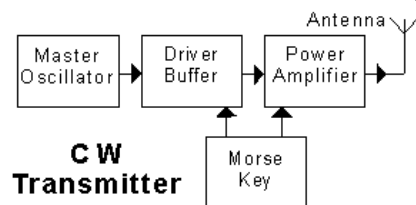

- turns the DC power to the transmitter on and off
- allows the oscillator signal to pass only when the key is depressed
- changes the frequency of the transmitted signal when the key is depressed
- adds an 800 Hz audio tone to the signal when the key is depressed

10. In the transmitter block diagram shown, the "power amplifier":

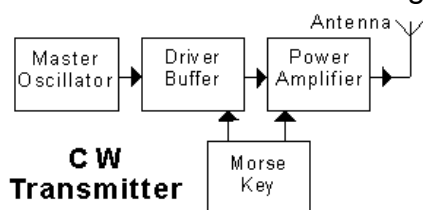

- a. need not have linear characteristics
- b. amplifies the bandwidth of its input signal
- c. must be adjusted during key-up conditions
- d. should be water-cooled

11. In the transmitter block diagram shown, the "speech amplifier":

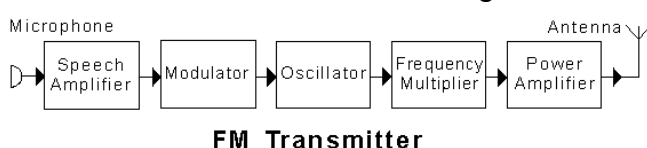

- a. amplifies the audio signal from the microphone
- b. is a spectral equalization entropy changer
- c. amplifies only speech, while discriminating against background noises
- d. shifts the frequency spectrum of the audio signal into the RF region

12. In the transmitter block diagram shown, the "modulator":

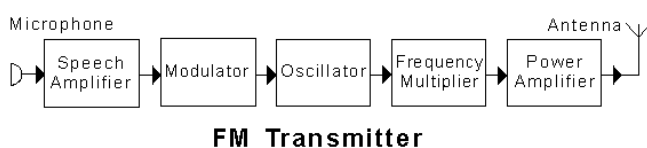

- a. is an amplitude modulator with feedback
- b. is an SSB modulator with feedback
- c. causes the speech waveform to gate the oscillator on and off
- d. causes the speech waveform to shift the frequency of the oscillator

13. In the transmitter block diagram shown, the "oscillator" is:

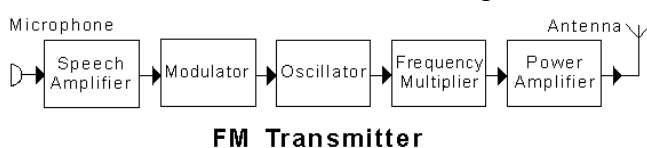

- a. an audio frequency oscillator
- b. a variable frequency RF oscillator
- c. a beat frequency oscillator
- d. a variable frequency audio oscillator

14. In the transmitter block diagram shown, the "frequency multiplier":



FM Transmitter

- translates the frequency of the modulated signal into the RF spectrum
- changes the frequency of the speech signal
- produces a harmonic of the oscillator signal
- multiplies the oscillator signal by the speech signal

15. In the transmitter block diagram shown, the "power amplifier":

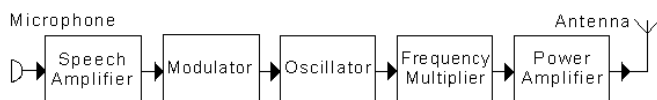

FM Transmitter

- increases the voltage of the mains to drive the antenna
- amplifies the audio frequency component of the signal
- amplifies the selected sideband to a suitable level
- amplifies the RF signal to a suitable level

16. The signal from an amplitude modulated transmitter consists of:

- a carrier and two sidebands
- a carrier and one sideband
- no carrier and two sidebands
- no carrier and one sideband

17. The signal from a frequency modulated transmitter has:

- an amplitude which varies with the modulating waveform
- a frequency which varies with the modulating waveform
- a single sideband which follows the modulating waveform
- no sideband structure

18. The signal from a balanced modulator consists of:

- a carrier and two sidebands
- a carrier and one sideband
- no carrier and two sidebands
- no carrier and one sideband

19. The signal from a CW transmitter consists of:

- a continuous, unmodulated RF waveform
- a continuous RF waveform modulated with an 800 Hz Morse signal
- an RF waveform which is keyed on and off to form Morse characters
- a continuous RF waveform which changes frequency in synchronism with an applied Morse signal

20. The following signal can be amplified using a non-linear amplifier:
- a. SSB
 - b. FM**
 - c. AM
 - d. DSBSC

=====

Section 19 Transmitter Theory

The Power Rating of a SSB linear amplifier

A power amplifier for SSB operation is required to be linear. This means that the waveform of the output signal must be a replica of the input waveform in all ways except amplitude - the output must be an amplified version of the input! The maximum power output before severe distortion takes place is the limit of successful linear amplifier operation.

The power output at the maximum level is the usual rating given for a linear amplifier. This is known as the "Peak Envelope Power", PEP.

The PEP is by definition, the average power output during one RF cycle at the crest of the modulating envelope.

The PEP rating and measurement are also sometimes used for amplifiers for other modes.

The RF output power from an amplifier is less than the total DC input power and signal input power to the amplifier. The difference is energy loss and appears as heat. Cooling facilities - fans etc. - are sometimes found on solid-state power amplifiers for protection from over-heating.

Question File: 19. Transmitter Theory: (1 question)

1. Morse code is usually transmitted by radio as:

- a. an interrupted carrier
- b. a voice modulated carrier
- c. a continuous carrier
- d. a series of clicks

=====

2. To obtain high frequency stability in a transmitter, the VFO should be:

- a. run from a non-regulated AC supply
- b. in a plastic box
- c. powered from a regulated DC supply
- d. able to change frequency with temperature

=====

3. SSB transmissions:

- a. occupy about twice the bandwidth of AM transmissions
- b. contain more information than AM transmissions
- c. occupy about half the bandwidth of AM transmissions
- d. are compatible with FM transmissions

=====

4. The purpose of a balanced modulator in a SSB transmitter is to:
- make sure that the carrier and both sidebands are in phase
 - make sure that the carrier and both sidebands are 180 degrees out of phase
 - ensure that the percentage of modulation is kept constant
 - suppress the carrier while producing two sidebands**
- =====
5. Several stations advise that your FM simplex transmission in the "two metre" band is distorted. The cause might be that:
- the transmitter modulation deviation is too high**
 - your antenna is too low
 - the transmitter has become unsynchronised
 - your transmitter frequency split is incorrect
- =====
6. The driver stage of a transmitter is located:
- before the power amplifier**
 - between oscillator and buffer
 - with the frequency multiplier
 - after the output low-pass filter circuit
- =====
7. The purpose of the final amplifier in a transmitter is to:
- increase the frequency of a signal
 - isolate the multiplier and later stages
 - produce a stable radio frequency
 - increase the power fed to the antenna**
- =====
8. The difference between DC input power and RF power output of a transmitter RF amplifier:
- radiates from the antenna
 - is dissipated as heat**
 - is lost in the feedline
 - is due to oscillating current
- =====
9. The process of modulation allows:
- information to be impressed on to a carrier**
 - information to be removed from a carrier
 - voice and Morse code to be combined
 - none of these
- =====
10. The output power rating of a linear amplifier in a SSB transmitter is specified by the:
- peak DC input power
 - mean AC input power
 - peak envelope power**
 - unmodulated carrier power
- =====

Section 20 Harmonics and Parasitics

Harmonics

Harmonics are multiples of a transmitted frequency which are the result of a non-linear action. They are present in any signal which has a distorted sinewave. Harmonics are the even or odd multiple of the fundamental transmitted frequency. For example, a transmitter at 3.5 MHz would have harmonics at 7, 10.5, 14, etc MHz.

Harmonics are typically produced by an over-driven stage somewhere in the system. An example is over-modulation of a transmitter ("flat-topping"). Reducing the microphone gain in this case will significantly reduce the harmonic output. Harmonic interference occurs at distinct frequencies.

Harmonics should be suspected if a transmitter on a lower frequency causes interference to a frequency which is a multiple of it. For example, a transmitter on the 10m band, at say 28 MHz, could cause interference to a television receiver receiving on TV Channel 2, which is 54 to 61 MHz. The probable cause is the second harmonic $2 \times 28 = 56$ MHz.

For TV and other frequency use, refer to the NZART CallBook (Page 8-9 in the 1998/99 edition) for the ***New Zealand Radio Spectrum Usage***. This information is also available from the Ministry of Commerce web page - look for document PIB21 at: <http://www.med.govt.nz/rsm/planning/nztable.html>

Harmonics can be produced within transmitters and receivers or outside of both. Harmonics generated within a transmitter must be filtered out. A filter in the output lead is usually installed by manufacturers. External filters are also used. Harmonics generated within a receiver generally cause cross-modulation or intermodulation.

Harmonics can also be generated by external causes - for example a bad connection between two metal surfaces, e.g. gutters, metal roofing, and antennas. The joint can oxidise and form a poor quality diode which when excited by an RF field produces harmonics

Harmonics which are not exactly on the frequency being received can sometimes be removed with a selective filter - band reject, high pass or low pass.

Generally, harmonics should be suppressed at their source.

Parasitic oscillations

With parasitic signals there is no simple mathematical relationship between the operating frequency and the interfering frequency. The effects may be the same as with harmonics - a VHF receiver being interfered with by a HF transmission. The cause is an additional and undesired oscillation from an oscillator or amplifier for which it was not designed. The circuit functions normally but the parasitic oscillation occurs simultaneously.

Parasitics are suppressed by adding additional components to the circuit to suppress the undesired oscillation without affecting the primary function of the circuit. A typical solution is to add a VHF choke (an inductor) or a small-value resistor (a "stopper") somewhere close to the active component in the offending circuit.

Question File: 20. Harmonics and Parasitics: (2 questions)

1. A harmonic of a signal transmitted at 3525 kHz would be expected to occur at:
- 3573 kHz
 - 7050 kHz
 - 14025 kHz
 - 21050 kHz

- =====
2. The third harmonic of 7 MHz is:
- 10 MHz
 - 14 MHz
 - 21 MHz
 - 28 MHz

- =====
3. The fifth harmonic of 7 MHz is:
- 12 MHz
 - 19 MHz
 - 28 MHz
 - 35 MHz

- =====
4. Excessive harmonic output may be produced in a transmitter by:
- a linear amplifier
 - a low SWR
 - resonant circuits
 - overdriven amplifier stages

- =====
5. Harmonics may be produced in the RF power amplifier of a transmitter if:
- the modulation level is too low
 - the modulation level is too high
 - the oscillator frequency is unstable
 - modulation is applied to more than one stage
- =====

6. Harmonics produced in an early stage of a transmitter may be reduced in a later stage by:
- increasing the signal input to the final stage
 - using FET power amplifiers
 - using tuned circuit coupling between stages
 - using larger value coupling capacitors
- =====
7. Harmonics are produced when:
- a resonant circuit is detuned
 - negative feedback is applied to an amplifier
 - a transistor is biased for class A operation
 - a sine wave is distorted
- =====
8. Harmonic frequencies are:
- always lower in frequency than the fundamental frequency
 - at multiples of the fundamental frequency
 - any unwanted frequency above the fundamental frequency
 - any frequency causing TVI
- =====
9. An interfering signal from a transmitter has a frequency of 57 MHz. This signal could be the:
- seventh harmonic of an 80 meter transmission
 - third harmonic of a 15 metre transmission
 - second harmonic of a 10 metre transmission
 - crystal oscillator operating on its fundamental
- =====
10. To minimise the radiation of one particular harmonic, one can use a:
- wave trap in the transmitter output
 - resistor
 - high pass filter in the transmitter output
 - filter in the receiver lead
- =====
11. A low-pass filter is used in the antenna lead from a transmitter:
- to reduce key clicks developed in a CW transmitter
 - to increase harmonic radiation
 - to eliminate chirp in CW transmissions
 - to reduce radiation of harmonics
- =====
12. The following is installed in the transmission line as close as possible to a HF transmitter to reduce harmonic output:
- a middle-pass filter
 - a low-pass filter
 - a high-pass filter
 - a band-reject filter
- =====

13. A low pass filter will:
- suppress sub-harmonics
 - reduce harmonics
 - always eliminate interference
 - improve harmonic radiation
- =====
14. A spurious transmission from a transmitter is:
- an unwanted emission unrelated to the output signal frequency
 - an unwanted emission that is harmonically related to the modulating audio frequency
 - generated at 50 Hz
 - the main part of the modulated carrier
- =====
15. A parasitic oscillation:
- is an unwanted signal developed in a transmitter
 - is generated by parasitic elements of a Yagi beam
 - does not cause any radio interference
 - is produced in a transmitter oscillator stage
- =====
16. Parasitic oscillations in a RF power amplifier can be suppressed by:
- pulsing the supply voltage
 - placing suitable chokes, ferrite beads or resistors within the amplifier
 - screening all input leads
 - using split-stator tuning capacitors
- =====
17. Parasitic oscillations in the RF power amplifier stage of a transmitter may occur:
- at low frequencies only
 - on harmonic frequencies
 - at high frequencies only
 - at high or low frequencies
- =====
18. Transmitter power amplifiers can generate parasitic oscillations on:
- the transmitter's output frequency
 - harmonics of the transmitter's output frequency
 - frequencies unrelated to the transmitter's output frequency
 - VHF frequencies only
- =====
19. Parasitic oscillations tend to occur in:
- high voltage rectifiers
 - high gain amplifier stages
 - antenna matching circuits
 - SWR bridges
- =====

20. Parasitic oscillations can cause interference. They are:
- a. always the same frequency as the mains supply
 - b. always twice the operating frequency
 - c. not related to the operating frequency
 - d. three times the operating frequency

=====

Section 21 Power Supplies

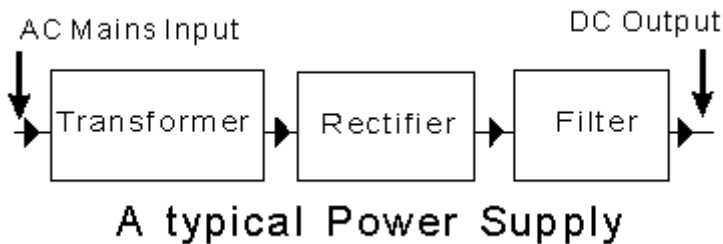

The typical power supply

The purpose of a power supply is to take electrical energy in one form and convert it into another. The usual example is to take supply from 230V AC mains and convert it into smooth DC.

This DC may be at 200 volt to provide (say) 200 mA as the high tension source for valve operation, or 5 volt at (say) 1 Amp to feed transistors and other solid-state devices.

The above diagram shows the separate stages in this conversion. Each will be considered in turn.

Protection

There should always be a fuse in the phase or active AC mains lead for protection if a fault develops in the equipment. The fuse should be of the correct rating for the task.

Keep some spare fuses handy!

The transformer

When two inductors (or more) are mounted together so their electromagnetic fields interact, we have a transformer. A power supply almost invariably, contains a transformer.

A transformer generally comprises two (or more) sets of coils (or windings) on a single core, designed so that maximum interaction and magnetic coupling takes place. The windings are insulated from each other and insulated from the core. The windings may be wound on top of each other.

At low frequencies the core may be made up from thin laminated soft-iron plates forming closed loops and designed to reduce **eddy current losses**. At higher

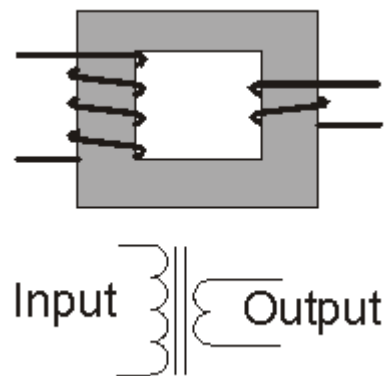

frequencies the core may be dust-iron, ceramic ferrite, or air-cored (as for RF coils).

The winding used to generate the magnetic flux is called the **primary** (connected to the AC supply). The winding in which current is induced is the **secondary** (or secondaries).

The input supply must be an alternating current. The input current sets up a changing magnetic field around the input or primary winding. That field sweeps the secondary and **induces** a current in that secondary winding.

The "turns ratio"

The number of turns on each winding determines the output voltage from the transformer. The output voltage from the secondary is proportional to the **ratio** of the turns on the windings.

For example, if the secondary has half as many turns as there are on the primary, and 100V AC is applied to the primary, the output will be 50V.

Transformers can be step-up or step-down (in voltage). With twice as many turns on the secondary as there are on the primary and 100 V applied, the output would be 200V.

A function of the transformer is to provide an AC supply at a voltage suitable for rectifying to produce a stated DC output.

The power output from the secondary cannot exceed the power fed into the primary. Ignoring losses, a step-down in voltage means that an increase in current from that lower-voltage winding is possible. Similarly, a step-up in voltage means a decrease in the current output. So the gauge of wire used for the secondary winding may be different to the wire used for the primary. (The term "gauge of wire" refers to its cross-sectional area.)

There will be some energy losses in a transformer, usually appearing as heat.

Rectifiers

There are three basic rectifier configurations, half-wave, full-wave and bridge. We will look at each in turn. We will use semiconductor rectifiers only.

The half-wave rectifier

Here is a very basic power supply, a transformer feeding a resistor as its load with a rectifier inserted in the circuit.

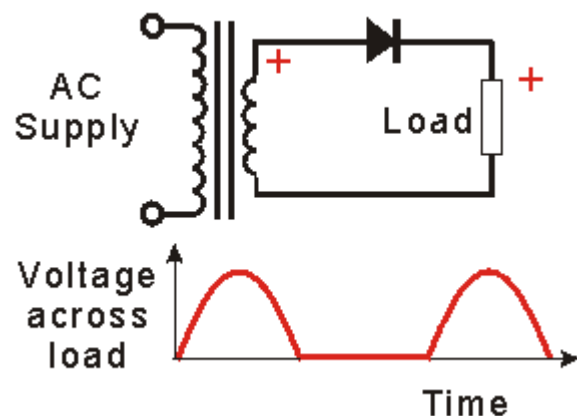

Without the rectifier, the load would have the full secondary alternating voltage appearing across it.

The rectifier will conduct each time its anode is positive with respect to its cathode.

So when the end of the secondary winding shown + is positive, the diode acts as a short-circuit and the + appears across the load. Current flows around the secondary circuit for the time that the diode is conducting. The voltage drop across the diode can be regarded as negligible - about 0.6 volt for a silicon device.

The waveform appearing across the load is shown in red on the graph. One-half cycle of the AC from the transformer is conducted by the rectifier, one half cycle is stopped. This is pulsating DC - half-wave rectified AC. Later we will put this through a filter to "smooth" it.

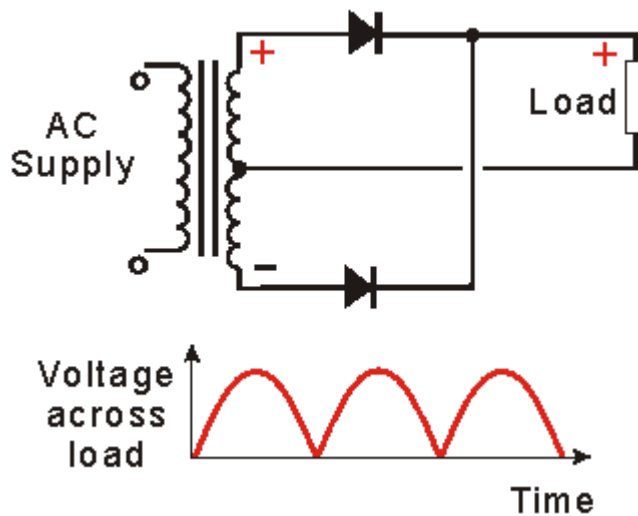

The full-wave rectifier

This is two half-wave rectifiers combined - it uses a center-tapped secondary winding and one additional diode.

Each side of the centre-tap has the same number of turns as our previous example - and each "works" for half the cycle as our half-wave rectifier did.

The "top half" of the secondary works with one diode like the half-wave circuit we have just considered.

When the polarity of the secondary changes, the upper diode shuts off and the lower diode conducts.

The result is that the lower diode "fills in" another half-cycle in the waveform when the upper diode is not conducting.

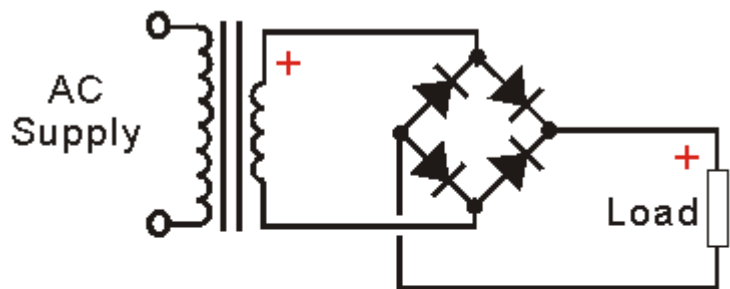

The bridge rectifier

This uses one single winding as the secondary and four diodes - two are conducting at any one time. Note the configuration of the diodes:

Diodes on parallel sides "point" in the same directions.

The AC signal is fed to the points where a cathode and anode join.

The positive output is taken from the junction of two cathodes.

The other end of the load goes to the junction of two anodes.

The operation is simple: Parallel-side diodes conduct at the same time. Note that the two + points are connected by a diode - same as in the two previous cases. The other end of the load returns to the transformer via the other parallel diode. When the polarity changes, the other two diodes conduct.

The output waveform is the same as the full-wave rectifier example shown before.

The main advantage? A simpler transformer - no centre-tap and no extra winding. Diodes can be small and cheap. A bridge rectifier can be purchased as a "block" with four wire connections.

Smoothing the output - the Filter

Each of the three circuits studied above produces an output that is DC, but it is DC with a waveform showing a large "ripple". The ripple is the waveform shown in red in the three examples. DC from a power supply should be smooth and non-varying in amplitude.

The half-wave circuit produced a ripple of the same frequency as the input signal, 50 Hz for input from a mains supply.

The other two examples produced a ripple that is twice the frequency of the mains supply - i.e. 100 Hz.

How can we remove the ripple? By using a filter circuit comprising filter capacitors and often a choke.

A capacitor wired across the load will charge up when the diode conducts and will discharge after the diode has stopped conducting. This reduces the size of the ripple. The blue lines in this diagram illustrate this.

The choice of capacitor is important. Electrolytic capacitors are generally used because a very large value capacity can be obtained in a small and cheap package.

The capacitor value chosen depends on the purpose for the supply. Capacities of the order of thousands of microfarads are common for low-voltage supplies. For supplies of 100V and upwards, the capacity is more likely to be 50 microfarad or so. It depends on other factors too. The voltage rating of the capacitor and its

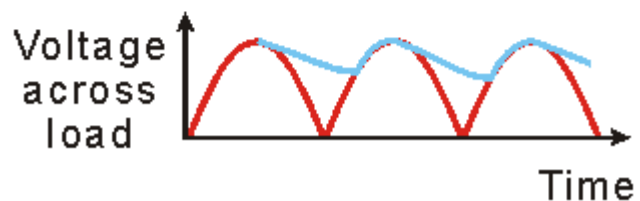
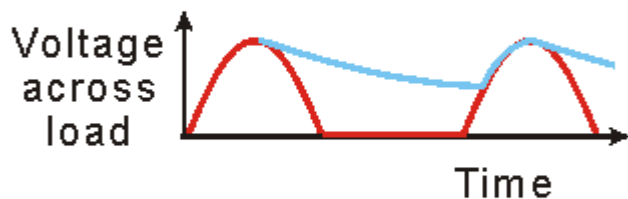
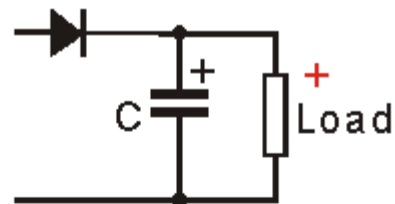

wiring polarity must be observed (electrolytic capacitors have + and - connections).

When a diode conducts, it must supply current to the load as well as charge up the capacitor. So the peak current passing through the diode can be very high. The diode only conducts when its anode is more positive than its cathode. You can see from the diagram how the addition of the capacitor has shortened this time.

The switch-on current through a power supply diode must also be considered. Charging a large capacitor from complete discharge will mean a high initial current.

A choke and an additional capacitor are often used to filter the output from a rectifier, as shown in this diagram.

The choke is an iron-cored inductor made for the purpose and it must be able to carry a rated DC current without its core saturating.

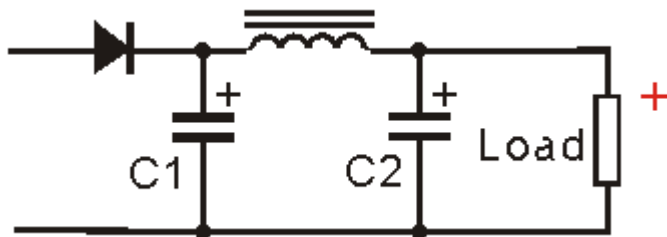

Internal resistance

All power supplies exhibit "internal resistance". A torch light will dim as its battery ages. The internal resistance of its battery increases with age. On open circuit, without the bulb connected, i.e. with no load current being drawn, the battery may show its normal voltage reading. When the load is applied and current flows, the internal resistance becomes apparent and the output voltage "droops" or "sags".

The effects of internal resistance can be reduced substantially by using a "regulator". This added electronic circuitry "winds up the voltage" as the output load current increases to keep the output voltage constant. It keeps the voltage constant as the load current widely varies

Choice of supply

A power supply (also a battery) must have sufficient reserve energy capacity to provide adequate energy to the device it is working with. For example, pen-light dry cells are not a substitute for a vehicle battery!

Similarly, a power supply for an amateur radio transceiver, (to substitute for a vehicle battery), must be chosen with care to ensure that the maximum load current can be supplied at the correct voltage rating without the voltage "sagging" when the load is applied.

Question File: 21. Power supplies: (1 question):

1. A mains operated DC power supply:
- a. converts DC from the mains into AC of the same voltage
 - b. converts energy from the mains into DC for operating electronic equipment
 - c. is a diode-capacitor device for measuring mains power
 - d. is a diode-choked device for measuring inductance power
- =====
2. The following unit in a DC power supply performs a rectifying operation:
- a. an electrolytic capacitor
 - b. a fuse
 - c. a crowbar
 - d. a full-wave diode bridge
- =====
3. The following unit in a DC power supply performs a smoothing operation:
- a. an electrolytic capacitor
 - b. a fuse
 - c. a crowbar
 - d. a full-wave diode bridge
- =====
4. The following could power a solid-state 10 watt VHF transceiver:
- a. a 12 volt car battery
 - b. 6 penlite cells in series
 - c. a 12 volt, 500 mA plug-pack
 - d. a 6 volt 10 Amp-hour Gel cell.
- =====
5. A fullwave DC power supply operates from the New Zealand AC mains. The ripple frequency is:
- a. 25 Hz
 - b. 50 Hz
 - c. 70 Hz
 - d. 100 Hz
- =====

6. The capacitor value best suited for smoothing the output of a 12 volt 1 amp DC power supply is:
- a. 100 pF
 - b. 10 nF
 - c. 100 nF
 - d. 10,000 uF
- =====
7. The following should always be included as a standard protection device in any power supply:
- a. a saturating transformer
 - b. a fuse in the mains lead
 - c. a zener diode bridge limiter
 - d. a fuse in the filter capacitor negative lead
- =====
8. A halfwave DC power supply operates from the New Zealand AC mains. The ripple frequency will be:
- a. 25 Hz
 - b. 50 Hz
 - c. 70 Hz
 - d. 100 Hz
- =====
9. The output voltage of a DC power supply decreases when current is drawn from it because:
- a. drawing output current causes the input mains voltage to decrease
 - b. drawing output current causes the input mains frequency to decrease
 - c. all power supplies have some internal resistance
 - d. some power is reflected back into the mains.
- =====
10. Electrolytic capacitors are used in power supplies because:
- a. they are tuned to operate at 50 Hz
 - b. they have very low losses compared to other types
 - c. they radiate less RF noise than other types
 - d. they can be obtained in larger values than other types
- =====

Section 22 Regulated Power Supplies

The need for voltage regulation

A voltage regulator is added to a power supply to minimise the "voltage droop" or "sag" when the load is applied and when the current load varies widely..

Some loads, for example a SSB transceiver, present a wide-changing current requirement. The power supply current for a SSB transceiver, supplied from a car battery, can fluctuate while the operator is speaking from a few amps to 50 amp or more, depending upon its transmitter power rating. The battery voltage must remain at a constant level throughout.

Similarly, a mains-powered power supply must be able to keep a constant voltage throughout a wide current range.

A regulated power supply has another stage added to follow the filter:

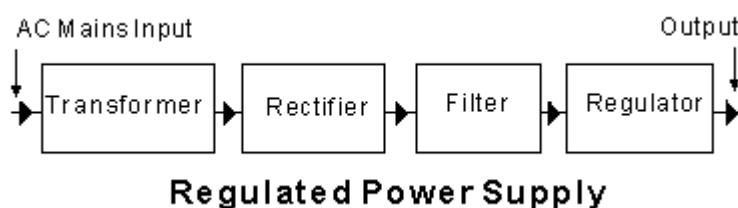

A simple regulator

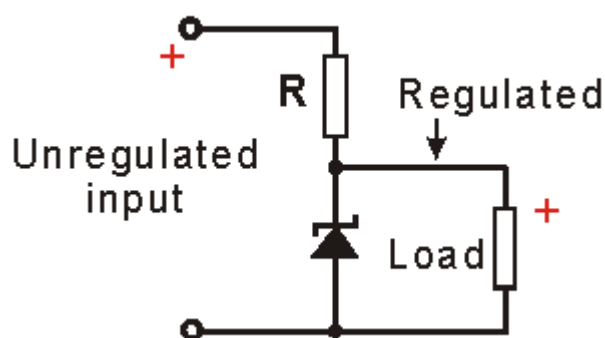

A zener diode is a silicon diode with a special level of doping to set its reverse break-down voltage level. It forms a simple regulator for low-voltage and small-current loads. The zener diode is reverse-biased and the reverse current is determined by the break-down voltage which depends on the doping level of the silicon. The breakdown voltage is repetitive provided the maximum

power dissipation is not exceeded. There is a catalogue choice of zener diode across a wide range of voltages. The zener effect occurs below 5 volt, above 5 volt the avalanche effect is used.

The resistor R is to limit the current through the diode and the load.

The Three-Terminal Regulator

This is an example of a regulator package, a 78L05. It looks like a standard transistor but it is a complete regulator for supplying a 5 volt output from (say) a 12 volt DC input. There are many other similar devices available for similar purposes. The pin-connection details are given. ("Three-legged regulators".)

The diode D1 is a hold-off diode, for protection against the possibility of the input connections being inadvertently reversed.

The diode will not conduct with reverse input potential so the regulator is protected. Diode D2 is protection for the device itself from a higher voltage appearing at its output compared to the input terminal.

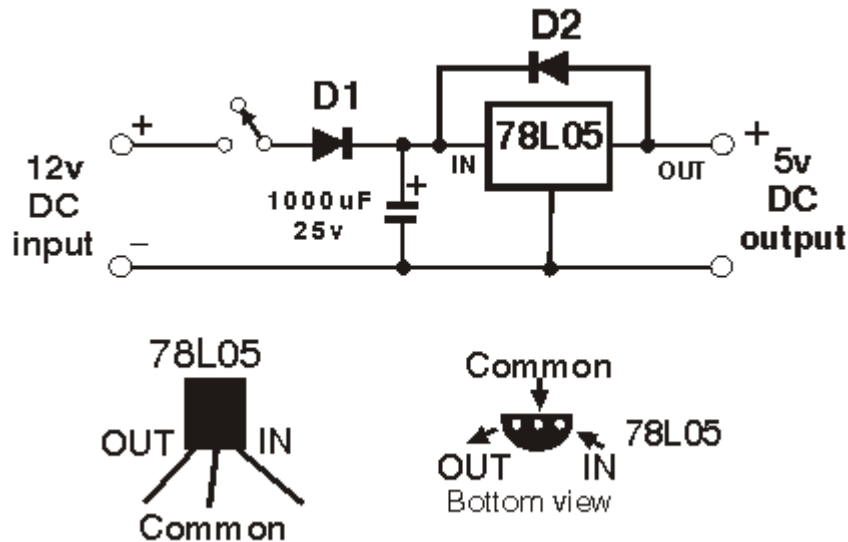

The Series Pass Regulator

A power transistor can be used to control the output voltage from a supply. A power transistor (or several in parallel) is in series with the output. The base is fed from a separately-regulated supply such as a three-terminal regulator or a zener diode. The transistor is in an emitter-follower configuration. Its emitter contains the load and the emitter follows the voltage at the base.

Protective measures

All the regulator circuits considered above require the input voltage to be considerably higher than the output. If the regulator fails, there is the distinct possibility that excessive voltage will be applied to the load. Over-voltage could damage the load and be very expensive if the load was a transceiver!

An electronic device known as a "**crowbar**" is usually installed to protect the load as a "last ditch" measure in the case of a regulator failure. The crowbar senses an over-voltage condition on the supply's output and acts instantly, firing a shorting device (usually a silicon-controlled-rectifier) across the supply output. This causes high currents in the supply which blows the mains fuse and effectively turns the supply off.

Current-limiting is another protective measure usually incorporated in a regulated supply. This is to reduce the current through the regulator to a low value under excessive load or short-circuit conditions to protect the series pass

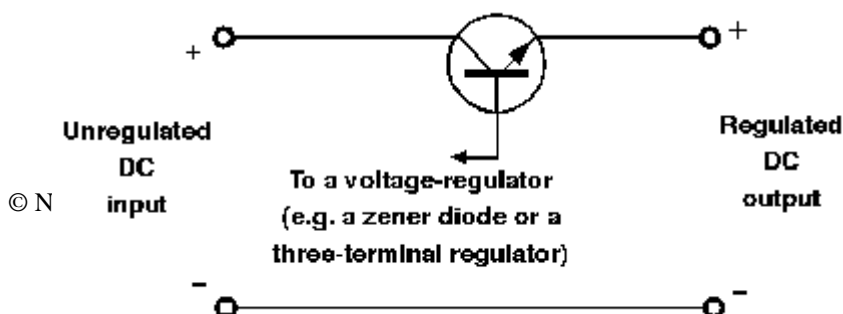

transistor from excessive power dissipation and possible destruction.

Question File: 22. Regulated Power supplies: (1 question):

1. The block marked 'Filter' in the diagram is to:

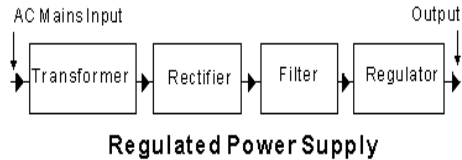

- a. filter RF radiation from the output of the power supply
 b. smooth the rectified waveform from the rectifier
 c. act as a 50 Hz tuned circuit
 d. restore voltage variations

2. The block marked 'Regulator' in the diagram is to:

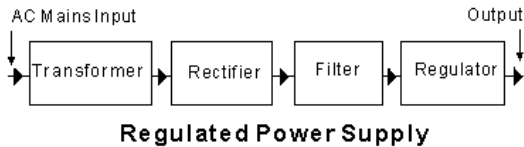

- a. regulate the incoming mains voltage to a constant value
 b. ensure that the output voltage never exceeds a dangerous value
 c. keep the incoming frequency constant at 50 Hz
 d. keep the output voltage at a constant value

3. The block marked 'Transformer' in the diagram is to:

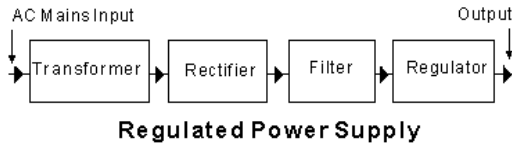

- transform the incoming mains AC voltage to a DC voltage
 - ensure that any RF radiation cannot get into the power supply
 - transform the mains AC voltage to a more convenient AC voltage
 - transform the mains AC waveform into a higher frequency waveform
- =====

4. The block marked 'Rectifier' in the diagram is to:

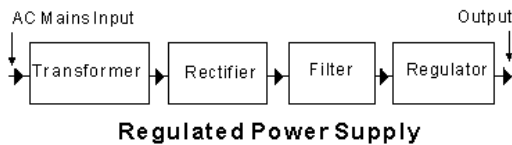

- turn the AC voltage from the transformer into a fluctuating DC voltage
 - rectify any waveform errors introduced by the transformer
 - turn the sinewave output of the rectifier into a square wave
 - Smooth the DC waveform
- =====

5. The block marked 'Regulator' in the diagram could consist of:

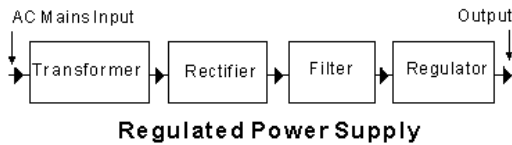

- four silicon power diodes in a regulator configuration
 - two silicon power diodes and a centre-tapped transformer
 - a three-terminal regulator chip
 - a single silicon power diode connected as a half-wave rectifier
- =====

6. In the block marked regulator below, a reverse diode may be present across the regulator. Its job is to:

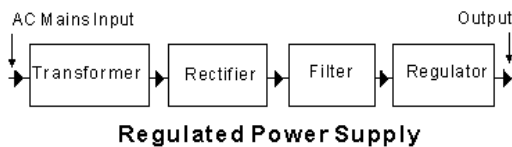

- Block negative voltages from appearing at the output
 - Blow a fuse if high voltages occur at the output
 - Blow a fuse if negative currents occur at the output
 - Bypass the regulator for higher voltage at its output compared with its input
- =====

7. A power supply is to power a solid-state transceiver. A suitable over-voltage protection device is a:

- a. crowbar across the regulator output
- b. 100 uF capacitor across the transformer output
- c. fuse in parallel with the regulator output
- d. zener diode in series with the regulator

=====

8. In a regulated power supply, the 'crowbar' is a:

- a. means to lever up the output voltage
- b. circuit for testing mains fuses
- c. last-ditch protection against failure of the regulator in the supply
- d. convenient means to move such a heavy supply unit

=====

9. In a regulated power supply, 'current limiting' is sometimes used to:

- a. prevent transformer core saturation
- b. protect the mains fuse
- c. minimise short-circuit current passing through the regulator
- d. eliminate earth-leakage effects

=====

10. The purpose of a series pass transistor in a regulated power supply is to:

- a. suppress voltage spikes across the transformer secondary winding
- b. work as a surge multiplier to speed up regulation
- c. amplify output voltage errors to assist regulation
- d. Allow for higher current to be supplied than the regulator would otherwise allow

=====

Section 23 General Operating Procedures

Note: This section includes:

Signal Reporting, QSL cards, the Phonetic Alphabet, and

Morse code abbreviations.

You have passed the examination, been issued a licence, and have a callsign. You have acquired a transmitter and receiver. You are now set to begin operating.

Golden Rules of Operating

LISTEN: This is the ***first*** rule. The strongest reason for listening before transmitting is to ensure that you won't interfere with anyone already using the frequency. The ***second*** reason for listening is that it may tell you a great deal about the condition of the bands. Although a band may be *dead* by popular consent at a particular time, frequent openings occur which you can take advantage of if you are listening at the right time. The ***third*** reason for listening is that if you can't hear 'em you are not likely to work 'em. Several short calls with plenty of listening spells will net you more contacts than a single long call. If you are running low power you may find it more fruitful to reply to someone else's CQ rather than call CQ yourself.

KEEP IT SHORT: If we all listened and never called, the bands would be very quiet indeed. So, if after listening, you have not made a contact, call CQ. The rules for calling CQ are:

1. Use ***your*** callsign frequently. Whoever you are calling knows their own callsign. They are interested in finding out yours.
2. Keep it short. Either they have heard you or they haven't. Either way, it is a waste of time giving a long call. If they are having difficulty in hearing you, use phonetics, but keep the overs as short as possible.

3. Examples:

When using CW send a 3 by 3 CQ. This means the letters CQ sent three times, followed by your callsign sent three times, and then the same group sent again, for example:

CQ CQ CQ de ZL1XYZ ZL1XYZ ZL1XYZ

sent twice and finally end with the letter *K* (for over) after the second group.

It is a nice and polite touch to add the endpiece "pse" (please):

"CQ CQ CQ de ZL1XYZ ZL1XYZ ZL1XYZ PSE K".

For voice operation you should repeat your call phonetically, for example:

CQ CQ CQ from ZL1XYZ ZL1XYZ ZL1XYZ

ZULU LIMA ONE X-RAY YANKEE ZULU

maybe three times and finish with:

calling CQ and listening.

4. Don't attempt to engage in DX "pileups" (many stations calling a rare callsign station) until you understand the accepted conventions for calling and replying.

A very bad practice may be observed in this activity. A station calling may carry out what amounts to an endurance exercise on the basis that the station who calls the longest gets the contact, purely because it is the only one that the DX station can hear clearly. This is unacceptable behaviour and should be avoided.

5. When you have made contact with that rare DX station make sure that they have your call and town correctly, give her/him your honest report, log your contact details, and then let the next station have its turn. Rare DX stations are not usually interested in the state of the weather in Eketahuna.

DO UNTO OTHERS: This rule if faithfully applied, would make the crowded HF bands far more tolerable.

1. Don't interfere with another station for any reason (except in extreme emergency).
2. Don't use full power to tune your antenna to resonance or when making matching adjustments with your antenna tuner. Always use a dummy load, or a noise bridge which enables you to tune your antenna accurately before transmitting.
3. Keep your power down to the minimum required for good communication.
4. Don't use excess audio drive or compression. This causes splatter and interference to other stations.

If there are other amateur operators in the area, it is courteous to make yourself known to them when you first begin transmitting. Check for things like cross modulation problems. If you are causing another amateur interference which is unrelated to equipment faults, you will have to come to a mutual arrangement about transmitting hours. The above suggestions apply to all modes of operation.

Some modes have their own particular rules, and these will be discussed in detail separately.

Repeater Operation

Repeaters were set up to provide a wider coverage on VHF and UHF as well as to provide facilities for emergency communication. So there are special rules governing repeater operation.

1. **Keep contacts short.** Three minutes is the generally accepted maximum length for an over using a repeater.
2. **Leave a pause between overs.** This is to enable weak stations with emergency traffic to make contact. *Three seconds* is the accepted break.
4. **Don't tune up on a repeater's input frequency.**

These are the main rules for using repeaters.

Other points to note when using repeaters or working simplex channels are:

1. Long CQs are not necessary or desirable on VHF or UHF channels. Just report that you are monitoring the channel. If anyone is listening and wants to contact you they will respond to your brief call.
2. When you want to contact someone through a repeater, it is not necessary to give a series of long calls. Either they are listening or they are not. A short call followed by: *are you are about Bill and Ben?* will usually bring forth a response. Some people respond to their name rather than to their callsign.

Do not keep triggering the repeater to make sure that it is there. This annoys the other people who monitor the repeater and it is not a good operating practice. A better way to announce your presence is to call and request a signal report from someone who may be monitoring the repeater. This may also result in an interesting and unexpected contact.

CW - or Morse Code - operating

Although CW operating appears to be slow compared with the use of voice, widespread use of abbreviations enables a CW contact to be conducted quite quickly. The first point to master in CW operation is the meaning of the various abbreviations for words and phrases in common use. A list is given below.

Other expressions are also used. An expression such as "up 2" means that the operator will be listening 2 kHz higher up the band at the end of his call.

The international [Q-Code](#) is also used for common instructions and consists of three-letter groups, each of which has a well defined meaning. The Q code is used to ask a question when followed by a question mark, and also used to provide a reply. For instance, if you are asked QRS? it means that the operator you are contacting is asking, *should I send more slowly*. The reply could be QRS 12 or whatever speed is suitable to the receiving operator.

When used on voice transmissions, many of the Q code signals take on a slightly different meaning, for instance the letters QRP indicate, *low power*, and QRX means, *standby*.

Operating CW is slightly different from voice transmission in that it is essential for the beginner to write everything down. As you become more proficient you will be able to copy in your head, but this comes only with practice.

Have a good supply of writing material handy. It adds to your difficulties if, when having to copy an incoming signal, pencils are lost, or blunt, or the supply of paper has run out. In your early days of CW sending, it helps to have a sheet of card on which is printed the name of your town, your own name, and a few details of the weather and so on. It is amazing how easy it is to forget even the spelling of your own name in morse code when in the middle of a contact. Operating convenience is fairly easy to arrange and gives a conversational style to CW transmissions. It also enables you to hear any interference on the frequency, and you can then stop to find out if you are still being heard. When calling CQ pause frequently.

Voice operation

A lot of your operation on the bands will be by voice, whether in the SSB or FM modes. Here are a few do's and don'ts.

1. **Speak clearly into the microphone.** It is a good idea to contact a local operator and ask for a critical report. Adjust your speaking distance from the microphone and audio gain control to obtain the best results. If you change your microphone or transceiver, repeat the process with the new equipment. It is often better to talk *across* the microphone instead of into it.
2. **If conditions are difficult, use phonetics** . A copy of the standard phonetic alphabet is below. This list is used and understood by all operators and will get through far better than any other phonetics you may invent.

3. During overseas contacts ***the use of local slang and abbreviations should be avoided*** as the person you are contacting may have only sufficient English to provide the essential QSL information.

4. The voice equivalent of break-in keying is VOX. This enables the transmitter to be automatically turned on with the first syllable of speech. Adjustments are provided on transceivers fitted with VOX which enable the audio gain, delay, and anti-vox, to be adjusted. These controls should be carefully set so that the transmitter is turned on as soon as speech commences, and that the delay is just sufficient to hold the transmitter on during the space between words, but released during a reasonable pause in the conversation. This will enable your contact to reply quickly to a comment, and permits an easy conversational flow.

Signal reporting

The **RST** system of signal reporting is based on a scale of 1 to 5 for **readability**, and 1 to 9 for signal **strength**. A **tone** figure of 1 to 9 is also given in the case of CW reports - for the purity of tone.

The **RST** System:

READABILITY

- 1 - Unreadable
- 2 - Barely readable, occasional words distinguishable
- 3 - Readable with considerable difficulty
- 4 - Readable with practically no difficulty
- 5 - Perfectly readable

SIGNAL STRENGTH

- 1 - Faint signals, barely perceptible
- 2 - Very weak signals
- 3 - Weak Signals
- 4 - Fair signals
- 5 - Fairly good signals
- 6 - Good signals
- 7 - Moderately strong signals
- 8 - Strong signals
- 9 - Extremely strong signals

TONE

- 1 - AC hum, very rough and broad
- 2 - Very rough ac, very harsh and broad
- 3 - Rough ac tone, rectified but not filtered
- 4 - Rough note, some trace of filtering
- 5 - Filtered rectified ac but strong ripple modulated
- 6 - Filtered tone, definite trace of ripple modulation

- 7 - Near pure tone, trace of ripple modulation
- 8 - near perfect tone, slight trace of modulation
- 9 - Perfect tone, no trace of ripple or modulation of any kind

The **R** readability part of the report is usually easy to resolve with a fair degree of honesty, although you will sometimes hear a report of readability 5, and "could you please repeat your name and location"!

The biggest problem in reporting seems to be the accuracy of the **S** signal strength reports.

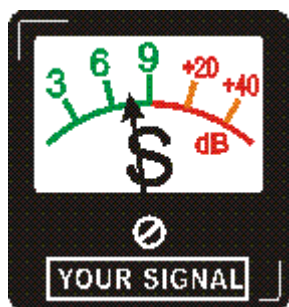

Some receivers are fitted with an "S" meter. The indication is usually related to the receiver's AGC level. [AGC](#) The meter may be a moving-coil or an LED bargraph. The usual scale is for an increase of +6 dB in the receiver input signal for each "S" point up to S9, with a +20 dB indication then up to +60 dB. In practice, on the HF bands, an S meter needle makes wide changes and at best is just a simple indicator of variations in the propagation path. Its best use may be for comparing two incoming signals, such as when your contact station changes antennas.

Variations in equipment, propagation, the type of antenna and power of the equipment used by the operator at the other end, can all influence a signal strength report. With these variables the best you can do is to be consistent in the signal strength reports you give and hope that your contact does the same. This applies particularly to DX contacts. However, if your local contacts begin to give you reports that are at variance with what you normally receive, it's time to have a good look at your antenna and equipment, as something may have become disconnected or out of adjustment.

The **T** part of the RST reporting system refers to the tone of the received signal and is used in CW reporting. On a scale of 1 to 9, a 1 would indicate a heavy AC hum. A 9, indicates a clean tone, as from a sine wave audio oscillator. It is unusual to hear a signal that is not T9 these days. The numbers in between give variations of the above conditions. Again, honesty of reporting. If a signal is not up to standard tell the operator. He will appreciate it. If your signal is not up to scratch, fix it. You owe this to other users of the bands.

When using FM these signal reports become meaningless. The audio level of an FM signal will not change with an increase in signal strength — the background noise will drop as the signal strength increases. This is called "quieting". A typical report could be "strength 5, very little noise". Signal reports from a repeater are generally meaningless, but a report to a user that he is fully limiting the repeater, or that his signal is breaking badly will sometimes help someone who may be checking a new site, or trying to access a repeater that he has not been able to work into before.

Other modes

The original digital means of communication was the Morse code and this is still in use as a method of transferring information by means other than voice. Today however Morse has been joined by a number of other methods each with its own advantages and disadvantages. RTTY, AMTOR, and Packet Radio, have all been given a great boost with the arrival of the computer and the advent of satellites with store and forward facilities. It is now possible to pass information to many parts of the world with a hand held transceiver, modem, and computer. Each of these means of communication has its own particular operating protocol and a study of it is well worthwhile before you venture into digital communications. [DIGITAL](#)

Confirming the contact - QSL cards [Q-Code](#)

Most amateurs follow up a contact with an exchange of QSL cards to confirm the contact. When you design one for yourself, remember that these cards are sometimes used to obtain awards and certificates and if used for this purpose must contain the following information:

1. Your callsign, the callsign of the station worked, and your address. This should appear on the same side as other QSL information.
2. The date and time of the contact. The date should have the name of the month written. For example, 5 March 1990. In the United States 5/3/90 means May 3rd 1990. Times should be expressed in Universal Time. If local time is used this should be stated. Remember that when using Universal Time, the date changes at midday in New Zealand. (1 p.m. during daylight saving time.)
3. Signal Report.
4. Frequency of operation.
5. Mode of operation. Some awards require the mode used by both stations to be stated. For example, 2-way SSB.
6. If the card is to be sent through the NZART QSL Bureau, the call of the station to whom the card is to be sent should be printed on the back of the card. If a QSL manager is used by the recipient, that is the call that should be used.
7. Other information which may be included is a description of equipment, NZART Branch number, County, and Maidenhead Locator.

The New Zealand Association of Radio Transmitters, NZART, operates a QSL bureau. Cards may be forwarded through this if you are a member. Details of the bureau are in the Annual NZART *CallBook*. If you send a card direct, it is a courtesy to send a self-addressed envelope and international reply coupons to cover the cost of return postage.



VIETNAM 3W6AR

Confirming our QSO with...



CONFIRM

Radio	Date	UTC	Band	RST	Mode
K8CX "TOU"	24 Sept 2000	14.07	21.240	57	SSB
Rig : YAESU FT 747 GX - 100W			Ant : Dipole - 15m highl.		

Nguyen - Bae - Ai Tax for nice QSO Pse QSL Tnx
 PO. Box 732 TTSG *Nguyen Cu anh*
 HO - CHI - MINH CITY *73, Bao Anh*

PITCAIRN ISLAND

PEOPLED BY THE DESCENDANTS OF
THE MUTINEERS OF THE HOUNTY

VR6TC



Radio *W9ABB* Conf. QSO on *14* Mes
 At *0622* G.M.T. *11-11* 19 *58*
 Ur am ssb Sigs *589* Revr HQ-12DX
 Xmtr DX-35 50 Watts Ant. Dipole
 QSL Courtesy WITAJ *73*
 P.O. Box 1, THOMAS CHRISTIAN
 PSE QSL TNX

ZL9CI

CAMPBELL ISLAND
POSITION: 52°33'S 169°09'E

IOTA OC-037
 ITU 60
 CQ 32
 GRID RD47





THE KERMADEC DX ASSOCIATION
 P O BOX 56099, TAWA, WELLINGTON, NEW ZEALAND
 email: z12hu@clear.net.nz

Frequency Bands and Metres

Amateur Radio frequency bands are often referred to in terms of wavelength. This Table relates the frequency bands to the wavelength equivalent:

Table of Frequency Bands and Metres equivalent:

Frequency Band	Metre Band
165-190 kHz	1750 metres
1800-1950 kHz	160 metres
3.50-3.90 MHz	80 metres
7.00-7.30 MHz	40 metres
10.10-10.15 MHz	30 metres
14.00-14.350 MHz	20 metres
18.068-18.168 MHz	17 metres
21.00-21.45MHz	15 metres
24.89-24.99 MHz	12 metres
27.12 MHz	11 metres
28.00-29.70 MHz	10 metres
50.00-54.00 MHz	6 metres
144.0-148.0 MHz	2 metres
430-440 MHz	70 centimetres

The Phonetic Alphabet:

This is an extract from the *International Radio Regulations*:

APPENDIX S14

Phonetic Alphabet

When it is necessary to spell out call signs, service abbreviations and words, the following letter spelling table shall be used:

<i>Letter to be transmitted</i>	<i>Code word to be used</i>	<i>Spoken as:</i>
A	Alfa	<u>AL</u> FAH
B	Bravo	<u>BRAH</u> VOH
C	Charlie	<u>CHAR</u> LEE or <u>SHAR</u> LEE
D	Delta	<u>DELL</u> TAH
E	Echo	<u>ECK</u> OH
F	Foxtrot	<u>FOKS</u> TROT

G	Golf	GOLF
H	Hotel	HOH TELL
I	India	IN DEE AH
J	Juliect	JEW LEE ETT
K	Kilo	KEY LOH
L	Lima	LEE MAH
M	Mike	MIKE
N	November	NO VEM BER
O	Oscar	OSS CAH
P	Papa	PAH PAH
Q	Quebec	KEH BECK
R	Romeo	ROW ME OH
S	Sierra	SEE AIR RAH
T	Tango	TANG GO
U	Uniform	YOU NEE FORM or OO NEE FORM
V	Victor	VIK TAH
W	Whiskey	WISS KEY
X	X-ray	ECKS RAY
Y	Yankee	YANG KEY
Z	Zulu	ZOO LOO

The following are general phonetics used by radio amateurs:

<i>Figure or mark to be transmitted</i>	<i>Code word to be used</i>	<i>Spoken as:</i>
0	zero	ZAY-ROH
1	one	WUN
2	two	TOO
3	three	THREE
4	four	FOWER
5	five	FIVE
6	six	SIX
7	seven	SEVEN
8	eight	AIT
9	nine	NINE
Decimal point	Decimal	DAY-SEE-MAL
Full stop	Stop	STOP

Morse code abbreviations

AA	all after
AB	all before
ABT	about
AGN	again
ANT	antenna
BC	broadcast interference
BCNU	be seeing you
CK	check
CL	closing down
CPI	copy
CQ	calling all stations
CUD	could
CUL	see you later
DE	this is; from
DX	distant foreign countries
ES	and
FB	fine; excellent
GB	goodbye
GE	good evening
GM	good morning
GN	good night
GUD	good
HI	high
HI HI	the CW laugh
HR	here
HW	how is
NR	near; number
NW	now
OC	old chap
OM	old man
OP	operator
OT	old timer
PSE	please
PWR	power
RX	receiver
RFI	radio frequency interference
RIG	equipment
RPT	repeat
SRI	sorry
TNX	thanks
TKS	thanks
TVI	television interference
UR	your
VY	very
WKD	worked
TX	transmitter
XTAL	crystal

XYL	wife
YL	young lady
73	best regards
88	love and kisses

Question File 23: General Operating Procedures: (1 Question)

1. The correct order for callsigns in a callsign exchange at the start and end of a transmission is:
 - a. the other callsign followed by your own callsign
 - b. your callsign followed by the other callsign
 - c. your own callsign, repeated twice
 - d. the other callsign, repeated twice

=====
2. The following phonetic code is correct for the callsign "ZL1AN":
 - a. zanzibar london one america norway
 - b. zulu lima one alpha november
 - c. zulu lima one able nancy
 - d. zulu lima one able niner

=====
3. The accepted way to call "CQ" with a SSB transceiver is:
 - a. "CQ CQ CQ this is ZL1XXX ZL1XXX ZL1XXX"
 - b. "This is ZL1XXX calling CQ CQ CQ"
 - c. "CQ to anyone, CQ to anyone, I am ZL1XXX"
 - d. "CQ CQ CQ CQ CQ this is New Zealand"

=====
4. A signal report of "5 and 1" indicates:
 - a. very low intelligibility but good signal strength
 - b. perfect intelligibility but very low signal strength
 - c. perfect intelligibility, high signal strength
 - d. medium intelligibility and signal strength

=====
5. The correct phonetic code for the callsign VK5ZX is:
 - a. victor kilowatt five zulu xray
 - b. victor kilo five zulu xray
 - c. victor kilo five zanzibar xray
 - d. victoria kilo five zulu xray

=====
6. The accepted way to announce that you are listening to a VHF repeater is:
 - a. "hello 6695, this is ZL2ZZZ listening"
 - b. "calling 6695, 6695, 6695 from ZL2ZZZ"
 - c. "6695 from ZL2ZZZ"
 - d. "ZL2ZZZ listening on 6695"

=====
7. A rare DX station calling CQ on CW and repeating "up 2" at the end of the call means the station:
 - a. will be listening for replies 2 kHz higher in frequency
 - b. will reply only to stations sending at greater than 20 wpm

- c. is about to shift his calling frequency 2 kHz higher
- d. will wait more than 2 seconds before replying to his call

=====

8. When conversing via a VHF or UHF repeater you should pause between
overs for about:
- a. half a second
 - b. 3 seconds**
 - c. 30 seconds
 - d. several minutes

=====

9. Before calling CQ on the HF bands, you should:
- a. listen first, then ask if the frequency is in use**
 - b. request that other operators clear the frequency
 - c. request a signal report from any station listening
 - d. use a frequency where many stations are already calling

=====

10. The phrase "you are fully quieting the repeater" means:
- a. your signal is too weak for the repeater to reproduce correctly
 - b. your signal into the repeater is strong enough to be noise-free on the
output frequency**
 - c. your modulation level is too low
 - d. you are speaking too quietly into the microphone.

=====

Section 24 Operating Procedures and Practice

Receiver facilities

RF and IF gain controls - Simple receivers for the broadcast band have one "gain control" only, this sets the level of audio gain. Communications receivers have other gain controls which work on stages in advance of the detector.

An RF gain control sets the gain ahead of the receiver mixer. Adjustment to the gain of the first stage in the receiver can assist reception in cases where front-end-overload may be bothersome. This occurs when trying to receive a weak signal adjacent in frequency to a very strong local signal.

An IF gain control gives an independent control over the amplification prior to the detector stage. Most of the amplification in a receiver takes place in the IF stages. There may be many IF stages and operator-gain-control can effect improved performance.

AGC - "Automatic Gain Control". Tuning a receiver from a weak signal to a very strong signal (and back again) calls for frequent adjustment to the receiver's gain control(s). This becomes tiresome and is a nuisance with a communications receiver when tuning across a band of frequencies.

HF signals fade and the received audio can change from loud to faint and back again at sometimes very fast intervals. This need to frequently adjust a gain control is also a nuisance and burdensome.

By sampling the strength of the signal being received (by rectifying it to produce a voltage) and by applying it to some of the amplifier stages, it is possible to automatically adjust the overall gain of a receiver. Tuning from a strong signal to a weak one, and the fading of a distant signal, will now have minimal effect on the level of audio heard from the speaker.

The signal-level sample for AGC applications may be taken from the detector or alternatively may be a rectified sample of the received audio. The AGC voltage is usually a DC voltage fed back to the IF amplifier stages where it controls the bias of the amplifiers,

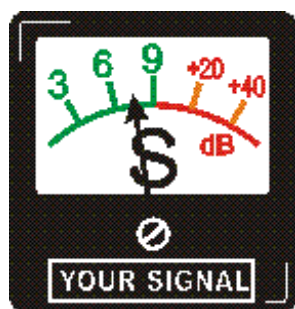

"S" meter - This is usually a meter front-panel-mounted on a receiver and calibrated in signal strength units and dB. It varies as the signal fades. It is usually an electronic voltmeter measuring the AGC voltage. With a strong signal, the AGC level will be high. With a weak signal, there may be no AGC voltage at all.

As an absolute level measurement, an S-meter is generally unsatisfactory. It is useful for making relative measurements between different received signals. Read it with caution!

Noise blanker - Noise at HF is often of the "impulse variety", short sharp spikes of noise that blank out reception. A noise blanker uses such spikes to form a gating signal in the path of the signal through the receiver. A noise spike then automatically mutes the receiver for the period of the noise spike. This makes reception more comfortable on the ears of the operator. The effectiveness of a noise blanker varies and depends on the type of noise and the signal levels being received.

Station switching

PTT - "Push-To-Talk". The simple way to control the send/receive function on a transceiver is to use a "pressel" switch on the microphone. Pushing the switch is a simple and intuitive action when sending a voice transmission. Release the switch and the transceiver reverts to receiving incoming signals. The switch usually operates a relay inside the transceiver. The relay does all the switching changes needed to change from receive to send and back again.

VOX - "Voice-Operated-Relay" or "Voice-Operated-Transmit" This technique can be used to simulate duplex operation (i.e. telephone-type conversations) when operating phone on the HF bands. It is an extension of PTT operating. Just speak! A sample of the speech audio from the microphone is amplified and rectified to provide a DC control signal. That DC signal operates the relay which does the station send/receive switching.

A VOX system must have a "fast attack, slow release" characteristic to be sure that the first syllable of a spoken statement is not severely clipped, and to ensure that the relay does not clatter excessively in and out between the spoken words.

Break-in keying - This system uses the Morse key as the send/receive switch too. When using the key, on first key-down, the station changes to transmit. Stop using the key - and the station receives. The "channel" in use can be monitored during key-up periods when sending. Conversational-type contacts are possible.

Operating techniques

RIT - "Receiver Incremental Tuning". A transceiver is usually a receiver and transmitter combination sharing a lot of common circuits - such as the various oscillators that determine its operating frequency. RIT provides a tuning facility so the receiver can be separately tuned for a few kHz each side of the transmit frequency, hence giving independent control over the receive frequency.

Split Frequency Operating - A transceiver is usually a receiver and transmitter combination which shares a lot of common circuits - such as the various oscillators that determine its operating frequency. There are occasions when separation of the send and receive frequencies is desirable - to receive on one frequency but to transmit on another. An obvious example is when a Novice grade operator is receiving a station outside the Novice segment of the band but transmits inside the Novice segment.

Pileup - Loose colloquial jargon used by radio amateurs to indicate the congestion that can occur when many stations suddenly call and try to work the same station, usually a station in some "rare DX" location. Discipline is needed to minimise this problem.

Station optimising

ALC - "Automatic Level Control". Just as we had AGC in a receiver, this is a similar thing for transmitters, usually for the linear amplifiers used in SSB transmitters. Its purpose is to prevent over-driving the linear amplifier stages especially the final amplifier.

It may also permit the peaks of an SSB signal to be limited in amplitude to enable an increase in the mean output power of the transmitter to improve the relative signal level at a distant receiver. This function can also involve processing the audio in the transmitter, known as "**compression**".

SWR bridge - Operating adjustments should be made to the Antenna Tuner for minimum reflected power indication on the SWR bridge. Appropriate antenna and transmission line adjustments should be made during installation for the same purpose.

VHF repeater working

A VHF (or UHF) repeater is a receiver and a transmitter connected together and sited on a hill-top or other high point - to get extended coverage.

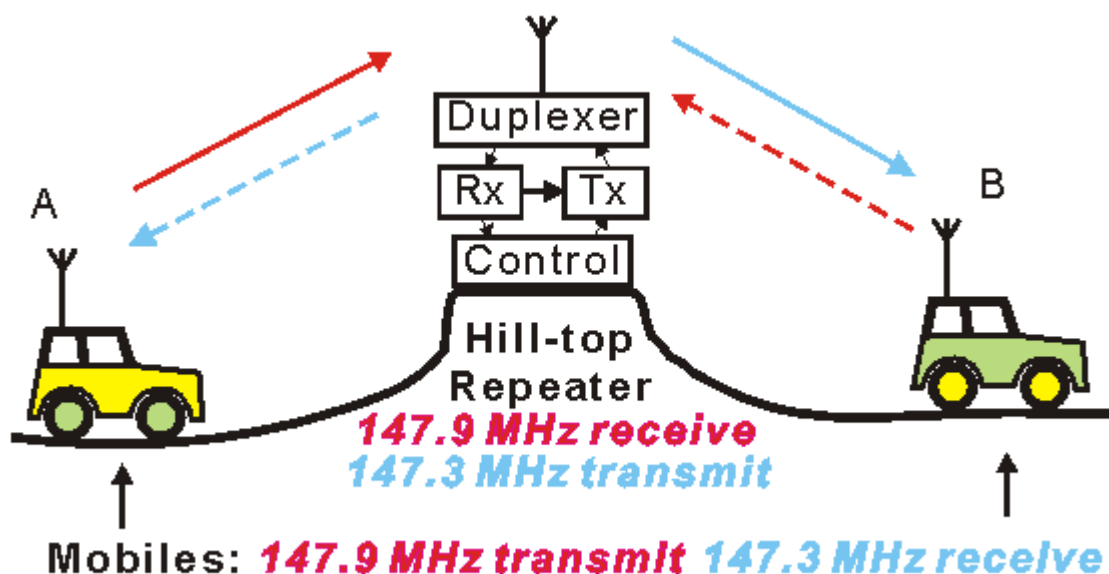

In this diagram, the repeater receiver (Rx) audio output is passed to the transmitter (Tx).

The Rx and Tx can share a common antenna. The receive and transmit signals are directed to the appropriate places by the "duplexer". This is a collection of high-Q tuned circuits, a passive device acting as filters for the repeater input and output signals.

The "control" detects a received carrier and switches the transmitter on - until the received carrier disappears when it then switches the transmitter off. So the push-to-talk switch in the mobile station also turns the repeater transmitter on and off for "talk-through" operating. The repeater receiver "squelch" is used to provide the transmitter send/receive function.

The frequency difference in this example is 600 kHz between the repeater receive and transmit frequencies. This is the standard "split" for repeaters operating in the 146 to 148 MHz band: i.e. it is **plus** 600 kHz **above** 147 MHz, and **minus** 600 kHz **on or below** 147 MHz. (The NZART CallBook gives details of the bandplans adopted in New Zealand and lists the frequencies and locations of amateur radio repeaters)

UHF repeaters operating in the 430 to 440 MHz band use a 5 MHz "split".

The carrier-operated switch at the repeater receiver may fail to operate when an input signal gets weak. When mobile stations are operating through the repeater, if a mobile moves into an area with little-or-no signal, the repeater may "drop out", there being insufficient signal to hold the repeater receiver open.

The carrier-operated switch at the repeater receiver is similar to the "**squelch**" operation in an FM receiver. FM receivers are very noisy in the absence of an

input signal. To make life comfortable for operators monitoring FM communications channels, a "squelch" mutes the receiver loudspeaker in the absence of an incoming signal. The squelch "opens" when a signal is received and the signal's audio is then heard from the speaker.

Repeater networks

New Zealand radio amateurs have built and installed 2-metre band (144 - 148 MHz) repeaters to provide most of the country with local area coverage.

The "**National System**" on the 70 cm band (430 to 440 MHz) is a chain of **linked repeaters**. These provide communication along the length of the country. Refer to the NZART CallBook for maps and other details about the operation of the National System.

Question File: 24. Practical Operating Knowledge: (2 questions)

1. You are mobile and talking through a VHF repeater. The other station reports that you keep "dropping out". This means:
 - a. your signal is drifting lower in frequency
 - b. your signal does not have enough strength to operate the repeater**
 - c. your voice is too low-pitched to be understood
 - d. you are not speaking loudly enough

=====

2. A "pileup" is:
 - a. an old, worn-out radio
 - b. another name for a junkbox
 - c. a large group of stations all calling the same DX station**
 - d. a type of selenium rectifier

=====

3. "Break-in keying" means:
 - a. unauthorised entry has resulted in station equipment disappearing
 - b. temporary emergency operating
 - c. key-down changes the station to transmit, key-up to receive**
 - d. the other station's keying is erratic

=====

4. A repeater operating with a "positive 600 kHz split":
 - a. listens on a frequency 600 kHz higher than its designated frequency**
 - b. transmits on a frequency 600 kHz higher than its designated frequency
 - c. transmits simultaneously on its designated frequency and one 600 kHz higher
 - d. uses positive modulation with a bandwidth of 600 kHz

=====

5. The standard frequency offset (split) for 2 metre repeaters in New Zealand is:
 - a. plus 600 kHz above 147 MHz, minus 600 kHz on or below 147 MHz**
 - b. plus 600 kHz below 147 MHz, minus 600 kHz on or above 147 MHz
 - c. minus 5 MHz below 147 MHz, plus 5 MHz kHz on or above 147 MHz
 - d. plus 5 MHz below 147 MHz, minus 5 MHz kHz on or above 147 MHz

=====

6. The standard frequency offset (split) for 70 cm repeaters in New Zealand is plus or minus:
- 600 kHz
 - 1 MHz
 - 2 MHz
 - 5 MHz
- =====
7. You are adjusting an antenna matching unit using an SWR bridge. You should adjust for:
- maximum reflected power
 - equal reflected and transmitted power
 - minimum reflected power
 - minimum transmitted power
- =====
8. The "squench" or "muting" circuitry on a VHF receiver:
- inhibits the audio output unless a station is being received
 - compresses incoming voice signals to make them more intelligible
 - reduces audio burst noise due to lightning emissions
 - reduces the noise on incoming signals
- =====
9. The "S meter" on a receiver:
- indicates where the squelch control should be set
 - indicates the standing wave ratio
 - indicates the state of the battery voltage
 - indicates relative incoming signal strengths
- =====
10. The "National System" is:
- the legal licensing standard of Amateur operation in New Zealand
 - a series of nationwide amateur radio linked repeaters in the 70 cm band
 - the official New Zealand repeater band plan
 - A nationwide emergency communications procedure
- =====
11. A noise blanker on a receiver is most effective to reduce:
- 50 Hz power supply hum
 - noise originating from the mixer stage of the receiver
 - ignition noise
 - noise originating from the RF stage of the receiver.
- =====
12. The purpose of a VOX unit in a transceiver is to:
- change from receiving to transmitting using the sound of the operator's voice
 - check the transmitting frequency using the voice operated crystal
 - enable a volume operated extension speaker for remote listening
 - enable the variable oscillator crystal
- =====

13. "VOX" stands for:
- volume operated extension speaker
 - voice operated transmit
 - variable oscillator transmitter
 - voice operated expander
- =====
14. "RIT" stands for:
- receiver interference transmutter
 - range independent transmission
 - receiver incremental tuning
 - random interference tester
- =====
15. The "RIT" control on a transceiver:
- reduces interference on the transmission
 - changes the frequency of the transmitter section without affecting the frequency of the receiver section
 - changes the transmitting and receiver frequencies by the same amount
 - changes the frequency of the receiver section without affecting the frequency of the transmitter section
- =====
16. The "split frequency" function on a transceiver allows the operator to:
- transmit on one frequency and receive on another
 - monitor two frequencies simultaneously using a single loudspeaker
 - monitor two frequencies simultaneously using two loudspeakers
 - receive CW and SSB signals simultaneously on the same frequency
- =====
17. The term "ALC" stands for:
- audio limiter control
 - automatic level control
 - automatic loudness control
 - automatic listening control
- =====
18. The AGC circuit is to:
- expand the audio gain
 - limit the extent of amplitude generation
 - minimise the adjustments needed to the receiver gain control knobs
 - amplitude limit the crystal oscillator output
- =====
19. Many receivers have both RF and AF gain controls. These allow the operator to:
- vary the receiver frequency and AM transmitter frequency independently
 - vary the low and high frequency audio gain independently
 - vary the receiver's "real" and "absolute" frequencies independently
 - vary the gain of the radio frequency and audio frequency amplifier stages independently
- =====

20. The term "PTT" means:
- a. push to talk
 - b. piezo-electric transducer transmitter
 - c. phase testing terminal
 - d. phased transmission transponder

=====

Question File 25 Q Codes (1 question)

Q CODES

These abbreviated three letter "Q" Codes were evolved by old-time telegraphy operators as a shorthand means for exchanging information about working conditions being experienced over the circuit in use.

You will be tested on only 10 of the 40 or so Q Code messages that are used in amateur radio communication.

Many can be used as a query if followed by a question mark, e. g. QRM? QTH? or as an answer to a query or as a statement of fact with no question mark, e.g. QTH Auckland, QTH San Francisco etc.

All Q codes may be used while operating CW and some are used during phone transmissions.

QRL? Means "Are you busy" [25.6] Commonly means "is the frequency in use?"

QRM Means "Your transmission is being interfered with" [25.1]

QRN Means "I am troubled by static" [25.2]

QRP? Means "Shall I decrease transmitter power?" [25.7]
Without the query means "I am running low power"

QRQ Means "Please send faster" [25.10]

QRS Means "Please send slower" [25.3]
With a query could mean "shall I (or we) send slower?"

QRZ? Means "Who is calling me?" [25.4]
Commonly means "who is on this frequency?" if you were unable to copy a callsign

QSB As part of a signal report means "your signals are fading" [25.8]

QSY? Means "Shall I change to transmission on another frequency?" [25.9]
Without the query means "I am going to change frequency/up 5 (kHz)/ to 28.459 etc.'

QTH? Means "What is your location?" [25.5]
Without the query "QTH Melbourne" means "my location is Melbourne"

You will need to memorize these Q Codes before the course starts

Hints

Often QRM and QRN are confused

QRM is **M**an made interference

QRN is **N**atural Noise

QRQ for **Q**uicker

QRS for **S**lower

Question File: 25. Q signals: (1 question)

1. The signal "QRM" means:
- your signals are fading
 - I am troubled by static
 - your transmission is being interfered with**
 - is my transmission being interfered with?
- =====
2. The signal "QRN" means:
- I am busy
 - I am troubled by static**
 - are you troubled by static?
 - I am being interfered with
- =====
3. The "Q signal" requesting the other station to send slower is:
- QRL
 - QRN
 - QRM
 - QRS**
- =====
4. The question "Who is calling me?" is asked by:
- QRT?
 - QRM?
 - QRP?
 - QRZ?**
- =====
5. The "Q" signal "what is your location?" is:
- QTH?**
 - QTC?
 - QRL?
 - QRZ?
- =====
6. The "Q" signal "are you busy?" is:
- QRM?
 - QRL?**
 - QRT?
 - QRZ?
- =====
7. The "Q" signal "shall I decrease transmitter power?" is:
- QRP?**
 - QRZ?
 - QRN?
 - QRL?
- =====
8. The "Q" signal "your signals are fading" is:
- QSO
 - QSB**
 - QSL
 - QRX
- =====
9. The signal "QSY?" means:
- shall I change to transmission on another frequency?**

- b. shall I increase transmitter power?
- c. shall I relay to ?
- d. is my signal fading?

=====

10. The "Q" signal which means "send faster" is:
- a. QRP
 - b. QRQ
 - c. QRS
 - d. QRN

Section 26 Transmission Lines

Carrying the signal

Transmission lines are the link between your station equipment, transmitter, receiver, transceiver, and the antenna. There are many different varieties but two major types of line predominate for frequencies in general use by radio amateurs. Parallel-conductor line, also known as twin-line, or open-wire line, consists of two parallel conductors held apart at a constant fixed distance by insulators or by insulation. This type of transmission line is "balanced". This means that each wire is "hot" with respect to earth.

Coaxial cable (coax) is the other major type and consists of two concentric conductors. It is a single wire surrounded by insulation and enclosed in an outer conductor, usually a braid. This is an "unbalanced" line, the outer sheath can be at earth potential, only the inner wire is "hot".

The transmitter power radiating from the antenna is less than that generated at the transmitter due to losses in the transmission line. These losses increase with higher SWR values, with higher frequencies and with increasing the length of the line. Most line loss occurs in the supporting insulation so open-wire lines have lower losses than heavily-insulated line.

Parallel lines

These come in various types. The flat TV "300-ohm ribbon" is an example. "Ladder-line", in which two parallel conductors are spaced by insulation "spreaders" at intervals is another. These lines are relatively cheap. Open-wire lines can be home-constructed using improvised "spreaders". These lines have low losses at HF frequencies.

These lines do have the disadvantage that they must be kept away from other conductors and earthed objects. They cannot be buried or strapped directly to a tower.

As the frequency increases, the open-wire line spacing becomes a significant fraction of the wavelength and the line will radiate some energy.

Because it is a balanced line, it can feed a dipole directly without the use of a "balun" at the antenna. (Baluns are discussed below.) Most transceivers have an unbalanced 50-ohm output impedance and a balun transformer will be required to feed a balanced line.

Parallel lines vary in impedance depending on the diameter and the spacing of the conductors. TV twin lead has an impedance of 300-ohm and ladder-line is usually 450 or 600-ohm.

Coaxial cable

Coaxial cable consists of two concentric conductors with dielectric insulation in the space between the conductors. The inner conductor carries the signal (i.e. it is "hot") the outer conductor is usually at earth potential and acts as a shield. This cable can be buried and run close to metal objects with no harmful effects.

Coax comes in various sizes from very small to large diameters. The small sizes are for low powers and short distances. The larger sizes have higher power-handling capabilities and usually lower losses. Most amateurs use 50-ohm cable while TV coax is usually 75-ohm.

The dielectric insulator is generally the main cause of energy loss. Most coax uses solid polyethylene and some types use a foam version. The foam version is lower loss but the solid version is more rugged. For very low loss purposes, a solid outer is used ("hardline"), and the inner conductor is supported by a spiral insulator or by beads. This type of coax is hard to work, cannot be bent very sharply and is generally expensive.

Impedance

An important characteristic of a transmission line is its "impedance". This can range from about 30 ohm for high-power coax to 600 to 1000 ohm for open-wire wide-spaced line. The unit of measurement is the ohm, but you cannot simply attach an ohm-meter to coax cable to measure its impedance.

The characteristic impedance of a line is not dependent on its length but on the physical arrangement of the size and spacing of the conductors. (Remember that when simply put, **impedance is the ratio of the voltage to the current**. A high voltage and low current means a high impedance. A low voltage and high current means low impedance).

Loads attached to the distant end of a line have an effect on the impedance "seen" at the input to the line.

When a line is terminated at the distant end with a termination impedance that is the same as the characteristic impedance of the line, the input to the line will be "seen" to be the characteristic impedance of that line. In other words, looking in to the input of this line, you "see" an infinitely-long line. This is ideal for the optimum transfer of power from the transmitter down the line to the antenna.



A line terminated with a load which is equal to the characteristic impedance of the line

In this diagram, the termination is the same value as the characteristic impedance of the line. The voltage across the line is shown as **E** for the various

points along the line and the current in the line at those same points is shown as **I**.

Note that the line is "flat" - there is no variation in the ratio of voltage to current (i.e. no variation in impedance) at any point along the line.

If there was such a thing as an infinitely long line, cutting a short length off it and terminating that short piece with a load equal to its characteristic impedance, would still make it indistinguishable at its input from an infinitely long line - as shown in the diagram above.

Line terminations

There are several classic cases of line termination which must be known and each will be described in turn.

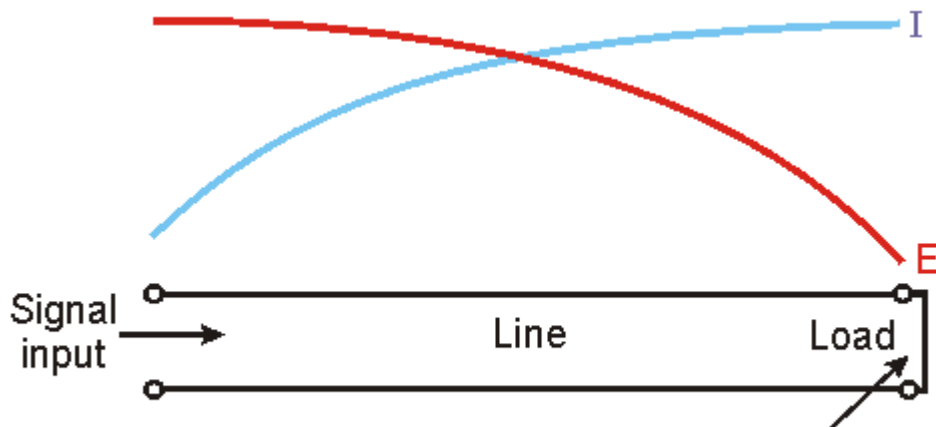

A line terminated with a short-circuit

For a line with a **short-circuit termination**, consider this approach:

A signal starts off and travels down the line. It reaches the distant end and finds the line to be short-circuited! What can it do? It turns around and travels back to the source. So there are now **TWO** waves travelling on the line but in different directions - the **forward wave** being still sent down the line, and the **reflected wave**, on its way back.

At any point on the line, the voltage across the line will be the **sum** of these two component waves, measured using an appropriate voltmeter.

But the voltage across the line at a short-circuit must be zero. So the reflected wave must be phased in such a way that the resultant voltage at the short-circuit is zero. See the **red E** curve above. Coming back down the line the voltage will increase as shown in the diagram above.

Likewise, at a short-circuit the current will be high. So the current in the line must be high at the termination and will decrease as you measure it back down the line. The current will follow the **blue I** curve shown above.

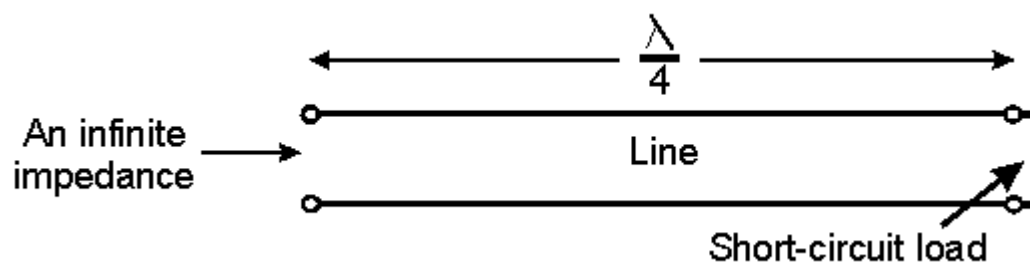

Impedance is the ratio of voltage to current. So at the load (a short-circuit) the impedance will be zero. As you travel back down the line, both E and I vary so the ratio between them is varying. When the line is one-quarter wavelength long, the impedance will be very high - approaching infinity. A similar thing happens when the line is **open-circuited**:

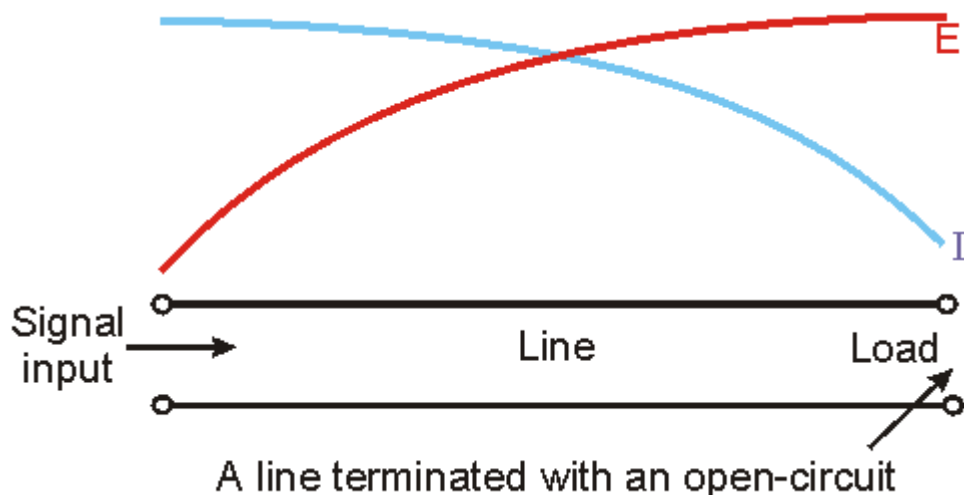

In this case, there will be a high voltage at the end of the line - the open-circuit. The current in the line must be zero there. So the impedance will be very high. Travelling back down the line, the impedance (the ratio of voltage to current) will decrease until at a quarter-wavelength point, the impedance will be seen to be zero.

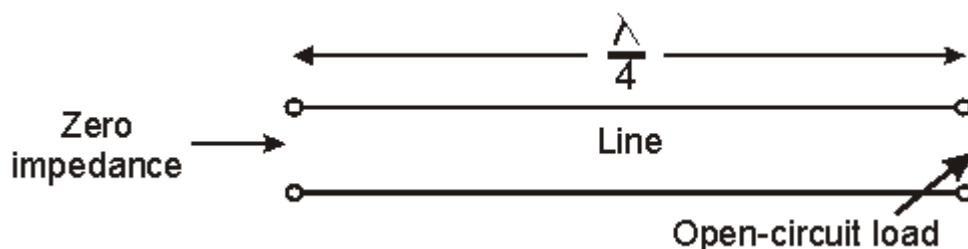

The quarter-wave length of line in effect **inverts** the impedance at its termination. Quarter-wave lengths of line are very useful for many applications especially at VHF and UHF.

The half-wave length of line can be considered as two quarter-wavelengths in cascade and its performance can be deduced from that approach.

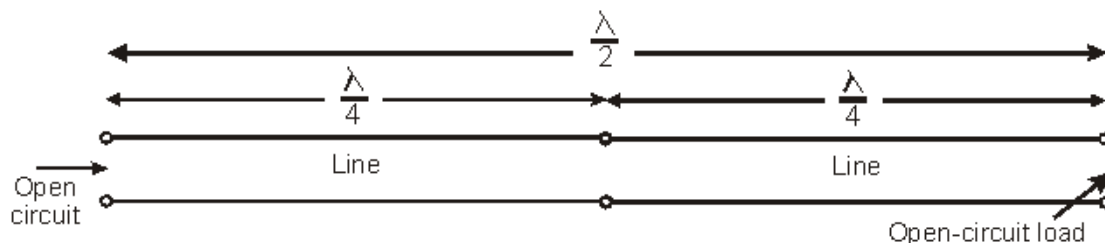

The input impedance of a **half-wave length** of line is a repeat of the termination at the distant end.

The Voltage Standing Wave Ratio (VSWR)

We have considered the line with a matched load, with a short-circuit termination and with an open-circuit termination. The practical values of load fall somewhere between these limits.

The VSWR (usually shortened to SWR) can be visualised by considering the forward and reflected waves in a line. If the antenna (the termination at the load end of the line) does not exactly match the line (i.e. is not exactly equal to the characteristic impedance of the line), then some energy will be reflected back down the line. So we have a forward wave (high energy) and a reflected wave (smaller than the forward wave) on the line. A pattern of peaks and troughs in the voltage measured between the line conductors will be found as you measure the voltage at points back down the line.

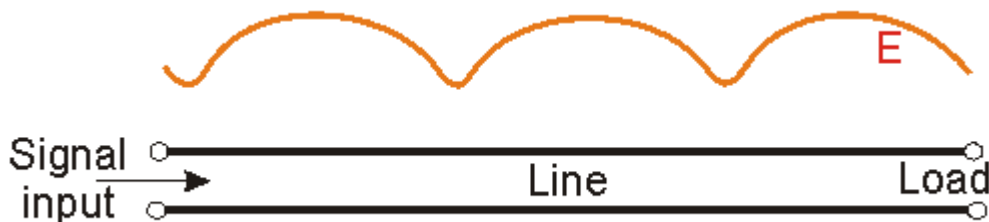

The SWR can be measured with a device known variously as a "reflectometer" or SWR bridge, or plain SWR meter.

The SWR meter is usually placed near to the transmitter. It distinguishes between the forward and reflected waves in the line. It gives an indication of whether the antenna is matched to the line by allowing the standing-wave-ratio to be measured. When inserted in the line between the transmitter and the antenna tuning unit, it also permits the antenna tuning unit to be adjusted.

Any variations from a "correct match" at the antenna (or load) end of the line can have a significant effect on the power radiated by the system:

1. The transmitter requires a "correct match" (usually 50-ohm) to the line for the best transfer of energy from the transmitter to the line.
2. The line requires a minimum SWR for least losses, and
3. the match from the line to the antenna should be correct to minimise the SWR on the line.

Variations from a "correct match" can also have undesirable effects on a transmitter to the point of causing overheating in the final stage and arcing in tuned circuits.

The "Antenna Tuner"

This is usually inserted in the transmission line adjacent to the transmitter with the transmission line to the antenna following and the antenna connected at the distant end of the line. The antenna tuner does not really tune the antenna at all. It does not adjust the length of the antenna elements, alter the height above ground, and so on. What it does do is to transform the impedance at the feedline input to a value that the transmitter can handle - usually 50 ohm. Think of the

antenna tuner as an adjustable impedance transformer and you will understand its function.

If the antenna is cut to resonance and is designed to match the impedance of the transmitter and feedline, an antenna tuner is not required. The transmitter is presented with a 50-ohm load (or something close to it) and into which it can deliver its full output power.

The "SWR bandwidth" is important. The SWR bandwidth of many antenna designs is usually limited to only some 200 or 300 kHz. If a dipole is cut to resonate with a 1:1 SWR at 7 MHz, you may find that the SWR is above 2.5:1 at 7200 kHz. Most modern transceivers will begin to reduce output or may automatically completely shut down at SWR's above 2:1.

With an antenna tuner in the same line, you can transform the impedance seen by the transmitter to 50-ohm, and reduce the SWR in the short piece of line between the transmitter and the antenna tuner to 1:1 again. The transceiver then delivers its full output again. The radiated power will be slightly reduced because of the higher losses on the line between the tuner and the antenna, attenuation due to the higher line currents associated with the higher SWR on that stretch of line.

This attenuation is caused by the fact that the matching function of the tuner has not changed the conditions on the line between the tuner and the antenna.

Velocity factor

A radio wave in free space travels with the speed of light. When a wave travels on a transmission line, it travels slower, travelling through a dielectric/insulation. The speed at which it travels on a line compared to the free-space velocity is known as the "velocity factor".

Typical figures are:

Twin line 0.82, Coaxial cable 0.66, (free space 1.0).

So a wave in a coaxial cable travels at about 66% of the speed of light (as an example).

In practice this means that if you have to cut a length of coaxial transmission line to be a half-wavelength long (for, say, some antenna application), the length of line you cut off will have to be 0.66 of the free-space length that you calculated.

Baluns

A balun is a device to convert a **balanced** line to an **unbalanced** line - and vice-versa. It comes in a variety of types.

The "transformer" type is probably the easiest version to understand. Consider a transformer with two windings, a primary and a secondary. The primary can be fed by a coaxial cable - the UNbalanced input. The secondary could be a centre-tapped winding with the tap connected to the outer of the coaxial input cable. The two ends of the secondary are then the BALanced connections. Impedance transformation can also be made by adjusting the number of turns on the primary and secondary windings.

When a balanced antenna, such as a dipole, is directly fed with coax (and unbalanced line), the antenna currents (which are inherently balanced) will run on the outside of the coax to balance the coaxial cable currents which are inherently unbalanced. This feedline current leads to radiation from the feedline itself as well as by the antenna and can distort the antenna radiation pattern. The RF can

travel back down the outside of the coax to the station and cause metal surfaces at the station to become live to RF voltages. RF shocks are unpleasant and burn the flesh. They should be avoided. To correct this, a balun should be used when connecting a balanced line to an unbalanced line and vice-versa. Baluns are used for connecting TV receivers (75-ohm unbalanced) to 300-ohm ribbon (balanced).

Using a single antenna for transmit and receive

A lot of trouble and expense goes into erecting a good feeder and antenna system for transmitting. It should also be used for receiving. This is usually the case with a transceiver.

With a station comprising a separate transmitter and receiver, a change-over relay can be fitted to switch the antenna feeder between the two items. It is usual - and desirable - for the unit not being used to be disabled. Extra poles on this same relay can be used to disable the device not being used.

Question File: 26. Transmission lines: (2 questions)

1. Any length of transmission line may be made to appear as an infinitely long line by:
 - a. shorting the line at the end
 - b. leaving the line open at the end
 - c. terminating the line in its characteristic impedance
 - d. increasing the standing wave ratio above unity

=====

2. The characteristic impedance of a transmission line is determined by the:
 - a. length of the line
 - b. load placed on the line
 - c. physical dimensions and relative positions of the conductors
 - d. frequency at which the line is operated

=====

3. The characteristic impedance of a 20 metre length of transmission line is 52 ohm. If 10 metres is cut off, the impedance will be:
- 13 ohm
 - 26 ohm
 - 39 ohm
 - 52 ohm**
- =====
4. The following feeder is the best match to the base of a quarter wave ground plane antenna:
- 300 ohm balanced feedline
 - 50 ohm coaxial cable**
 - 75 ohm balanced feedline
 - 300 ohm coaxial cable
- =====
5. The designed output impedance of the antenna socket of most modern transmitters is nominally:
- 25 ohm
 - 50 ohm**
 - 75 ohm
 - 100 ohm
- =====
6. To obtain efficient transfer of power from a transmitter to an antenna, it is important that there is a:
- high load impedance
 - low load impedance
 - correct impedance match between transmitter and antenna**
 - high standing wave ratio
- =====
7. A coaxial feedline is constructed from:
- a single conductor
 - two parallel conductors separated by spacers
 - braid and insulation around a central conductor**
 - braid and insulation twisted together
- =====
8. An RF transmission line should be matched at the transmitter end to:
- prevent frequency drift
 - overcome fading of the transmitted signal
 - ensure that the radiated signal has the intended polarisation
 - transfer maximum power to the antenna**
- =====
9. A damaged antenna or feedline attached to the output of a transmitter will present an incorrect load resulting in:
- the driver stage not delivering power to the final
 - the output tuned circuit breaking down
 - excessive heat being produced in the transmitter output stage**
 - loss of modulation in the transmitted signal
- =====
10. A result of mismatch between the power amplifier of a transmitter and the antenna is:
- reduced antenna radiation**

- b. radiation of key clicks
- c. lower modulation percentage
- d. smaller DC current drain

=====

11. Losses occurring on a transmission line between a transmitter and antenna result in:

- a. less RF power being radiated
- b. a SWR of 1:1
- c. reflections occurring in the line
- d. improved transfer of RF energy to the antenna

=====

12. If the characteristic impedance of a feedline does not match the antenna input impedance then:

- a. standing waves are produced in the feedline
- b. heat is produced at the junction
- c. the SWR drops to 1:1
- d. the antenna will not radiate any signal

=====

13. A result of standing waves on a non-resonant transmission line is:

- a. maximum transfer of energy to the antenna from the transmitter
- b. perfect impedance match between transmitter and feedline
- c. reduced transfer of RF energy to the antenna
- d. lack of radiation from the transmission line

=====

14. A quarter-wave length of 50-ohm coaxial line is shorted at one end. The impedance seen at the other end of the line is:

- a. zero
- b. 5 ohm
- c. 150 ohm
- d. infinite

=====

15. A switching system to use a single antenna for a separate transmitter and receiver should also:

- a. disable the unit not being used
- b. disconnect the antenna tuner
- c. ground the antenna on receive
- d. switch between power supplies

=====

16. An instrument to check whether RF power in the transmission line is transferred to the antenna is:

- a. a standing wave ratio meter
- b. an antenna tuner
- c. a dummy load
- d. a keying monitor

=====

17. This type of transmission line will exhibit the lowest loss:

- a. twisted flex
 - b. coaxial cable
 - c. open-wire feeder
 - d. mains cable
- =====

18. The velocity factor of a coaxial cable with solid polythene dielectric is about:
- a. 0.66
 - b. 0.1
 - c. 0.8
 - d. 1.0

=====

19. This commonly available antenna feedline can be buried directly in the ground for some distance without adverse effects:

- a. 75 ohm twinlead
- b. 300 ohm twinlead
- c. 600 ohm open-wire
- d. coaxial cable

=====

20. If an antenna feedline must pass near grounded metal objects, the following type should be used:

- a. 75 ohm twinlead
 - b. 300 ohm twinlead
 - c. 600 ohm open-wire
 - d. coaxial cable
- =====

Section 27 Antennas

Wavelength and frequency

A useful and fundamental measurement in radio antenna work is the "half wavelength". We must know how to calculate it. It gives the desired physical length of an antenna for any operating frequency.

Wavelength, frequency, and the speed of light, are related. The length of a radio wave for a given frequency when multiplied by that operating frequency, gives the speed of light.

The relationship is:

Speed of light = f times λ , i.e. $c = f \times \lambda$, ($\lambda = \text{lambd a}$),
where f is the frequency and λ is the wavelength.

Knowing that the speed of light is $c = 3 \times 10^8$ metres per second, and knowing our operating frequency, we can derive the wavelength of a radio wave by transposition as follows:

Wavelength (*in metres*) = 300 **divided by** the frequency *in MHz* .

A simple way to remember this is to remember 10 metres and 30 MHz, (to get the value of the constant, 300 !).

That gives a **wavelength!** The half-wavelength of a wave is **half** of the wavelength figure you obtain!

So a half-wavelength at 10 metres (30 MHz) will be 5 metres. The amateur 10 metre band is 28 to 29.7 MHz so a half-wavelength for that band will be a little longer than 5 metres. Pick a frequency and calculate it!

Dipoles

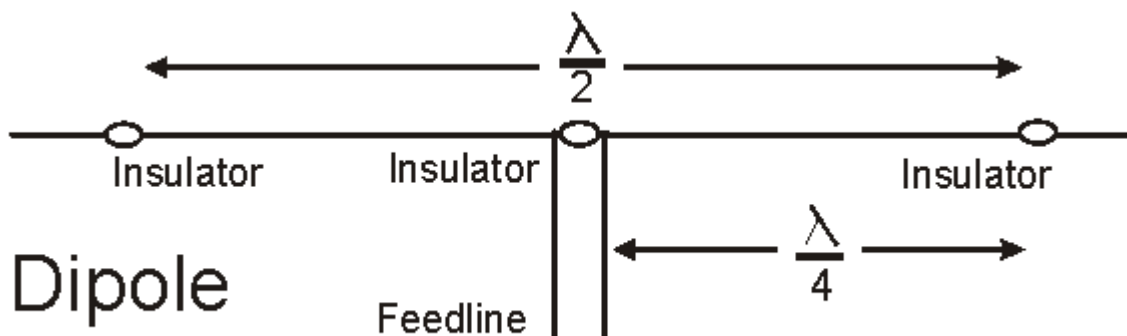

The fundamental antenna is the **dipole**. It is an antenna in two parts or poles. It is usually a one-half wavelength in overall length and is fed at the middle with a balanced feedline. One side of the antenna is connected to one side of the line and the other to the remaining side either directly or through some sort of phasing line.

When making a half-wave dipole for HF frequencies, one usually has to reduce the length by about 2 percent to account for capacitive effects at the ends. This is best done after installation because various factors such as the height above ground and other nearby conducting surfaces can affect it.

The feedpoint impedance of a half-wave dipole, installed about one wavelength or higher above ground (i.e. in "free space"), is 72 ohm. When the ends are lowered (i.e. into an "inverted V"), the impedance drops to around 50 ohms. The ends of the antenna should be insulated as they are high-voltage low-current points. The connections of the feedline to the antenna should be soldered because the centre of the dipole is a high-current low-voltage point.

The radiation pattern of a dipole in free space has a minimum of radiation in the direction off the ends of the dipole and a maximum in directions perpendicular to it. This pattern degrades considerably when the dipole is brought closer to the ground.

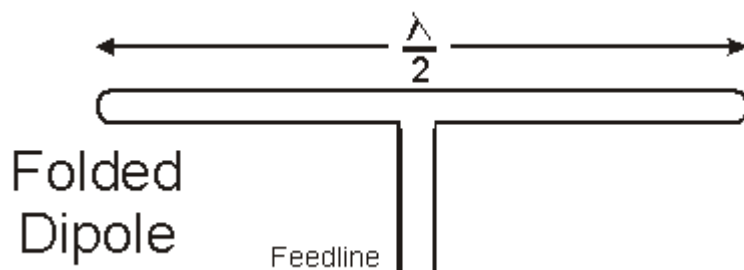

A modified version of the simple dipole is the **folded dipole**. It has two half-wave conductors joined at the ends and one conductor is split at the half-way point where the feeder is attached.

If the conductor diameters are the same, the feedpoint impedance of the folded dipole will be four times that of a standard dipole, i.e. 300 ohm.

The height above the ground

The height of an antenna above the ground, and the nature of the ground itself, has a considerable effect on the performance of an antenna and its angle of radiation. See [PROPAGATION](#)

The physical size of a dipole

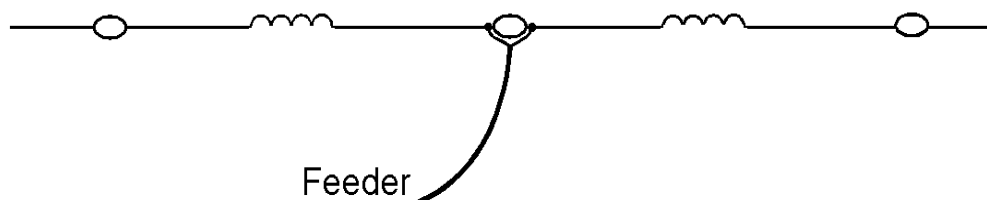

A wire dipole antenna for the lower amateur bands is sometimes too long to fit into a smaller property. The antenna can be physically shortened and it can still act as an electrical half-wave antenna by putting loading coils in each leg as shown in this diagram. With careful design, performance is still acceptable. Installing such "loading coils" lowers the resonant frequency of an antenna.

Multi-band dipoles

A simple half-wave dipole cut to length for operation on the 40m band (7 MHz) will also operate on the 15m band without any changes being necessary. This is because the physical length of the antenna appears to be one-and-one-half wavelengths long at 15 metres (21 MHz), i.e. three half-wavelengths long. A dipole antenna can be arranged to operate on several bands using other methods. One way is to install "traps" in each leg.

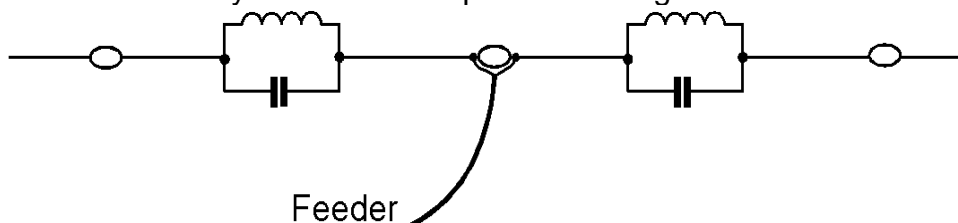

These are parallel-tuned circuits as shown in this diagram (enlarged to show the circuitry). The traps are seen as "high impedances" by the highest band in use and the distance between the traps is a half-wavelength for that band. At the frequencies of lower bands, the traps are seen as inductive and the antenna appears as a dipole with loading coils in each leg. With clever and careful design, operation becomes possible on a range of amateur bands.

Baluns

Dipoles should be fed with a "balanced line".

Vertical antennas

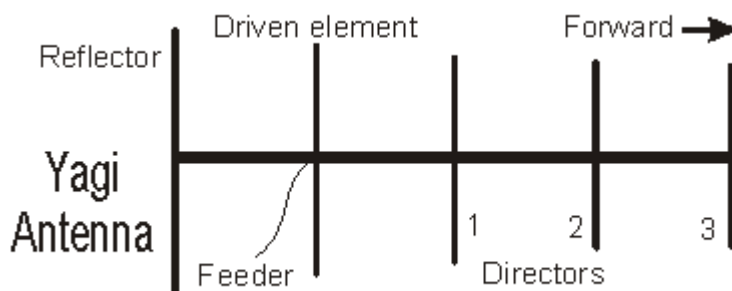

The simplest vertical is the Marconi which is a quarter-wave radiator above a ground-plane. It has a feedpoint impedance over a perfect ground of 36 ohm.

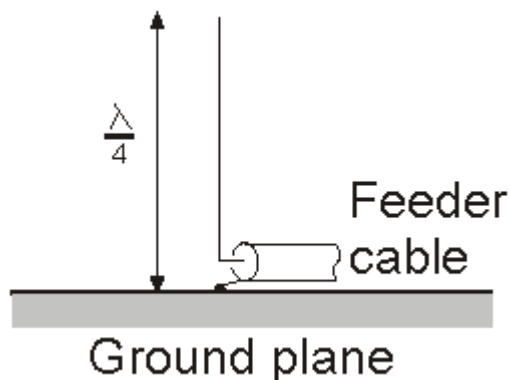

Above real ground it is usually between 50 and 75 ohm. This makes a good match for 50 ohm cable with the shield going to ground. For a given wavelength it is the smallest antenna with reasonable efficiency and so is a popular choice for mobile communication. It can be thought of half of a dipole with the other half appearing as a virtual image in the ground. A longer antenna can produce even lower radiation angles although these antennas become a bit large to easily construct. A

length often used for VHF mobile operation is the 5/8th wavelength. This length has a higher feed impedance and requires a matching network to match most feeder cables.

Vertical antennas require a good highly conductive ground. If the natural ground conductivity is poor, quarter-wave copper wire radials can be laid out from the base of the vertical to form a virtual ground.

Vertical antennas provide an omni-directional pattern in the horizontal plane so they receive and transmit equally well in all directions. This also makes them susceptible to noise and unwanted signals from all directions.

Vertical antennas are often used by DX operators because they produce low angle radiation that is best for long distances.

Beams

To improve signal transmission or reception in specific directions, basic elements, either vertical or horizontal, can be combined to form arrays. The most common form is the Yagi-Uda parasitic array commonly referred to as a Yagi array or beam.

It consists of a driven element which is either a simple or folded dipole and a series of parasitic elements arranged in a plane. The elements are called parasitic because they are not directly driven by the transmitter but rather absorb energy from the radiated element and re-radiate it.

Usually a Yagi will have one element behind the driven element (called the reflector), and one or more elements in front (called the directors). The reflector will be slightly longer than the driven element and the directors will be slightly shorter. The energy is then concentrated in a forward direction.

To rotate the beam, the elements are attached to a boom and in turn to a mast through some sort of rotator system.

Other antenna types can be constructed to give directivity. The size and weight, with wind resistance, are important. The **cubical quad** is a light-weight antenna for home-construction and it can provide good performance. It consists of two or more "square" wire cage-like elements.

Antenna measurements

Most antenna performance measurements are given in decibels. Important figures for a beam antenna are the forward gain, front-to-side ratio, and front-to-back ratio.

Forward gain is often given related to a simple dipole. For example, if the forward gain is said to be 10 dB over a dipole, then the radiated energy would be 10 times stronger in its maximum direction than a simple dipole.

Another comparison standard is the isotropic radiator or antenna. Consider it to be a theoretical point-source of radio energy. This is a hypothetical antenna that will radiate equally well in all directions in all planes - unlike a real vertical antenna which radiates equally well only in the horizontal plane. A dipole has a 2.3 dB gain over the isotropic radiator.

A front-to-back ratio of 20 dB means that the energy off the back of the beam is one-hundredth that of the front. Similar figures apply to the front-to-side ratio.

Another antenna measurement is the bandwidth or range of frequencies over which the antenna will satisfactorily operate. High gain antennas usually have a narrower bandwidth than low gain antennas. Some antennas may only cover a narrow part of a band they are used in while others can operate on several bands. Other antennas may be able to operate on several bands but not on frequencies in-between those bands.

Dummy loads

A dummy load, or dummy antenna, is not really an antenna but is closely related to one. It is a pure resistance which is put in place of an antenna to use when testing a transmitter without radiating a signal.

Commonly referred to as a termination, if correctly matched to the impedance of the line, when placed at the end of a transmission line it will make the transmission line look like an infinite line.

Most transmitters are 50 ohm output impedance so a dummy load is simply a 50 ohm non-inductive resistor load. The resistor can be enclosed in oil to improve its power-handing capacity. The rating for full-power operation may be for only a short time so be aware of the time and power ratings of your dummy load before testing for long periods at full power. The things can get very hot!

Question File: 27. Antennas: (4 questions)

1. In this diagram the item U corresponds to the:

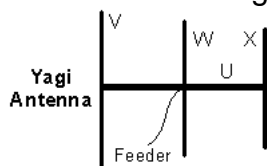

- a. boom
b. reflector
c. driven element
d. director

2. In this diagram the item V corresponds to the:

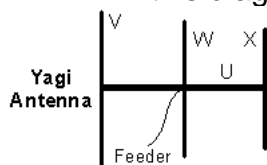

- a. boom
b. reflector
c. driven element
d. director

3. In this diagram the item X corresponds to the:

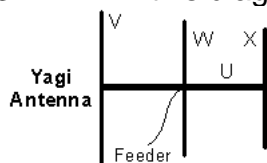

- a. boom
b. reflector
c. director
d. driven element

4. The antenna in this diagram has two equal lengths of wire shown as 'X' forming a dipole between insulators. The optimum operating frequency will be when the:

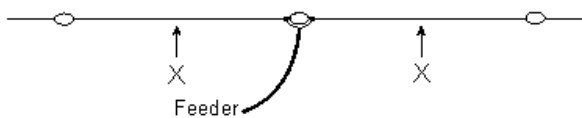

- a. length $X+X$ equals the signal wavelength
b. dimensions are changed with one leg doubled in length
c. length $X+X$ is a little shorter than one-half of the signal wavelength
d. antenna has one end grounded

5. The antenna in this diagram can be made to operate on several bands if the following item is installed at the points shown at 'X' in each wire:

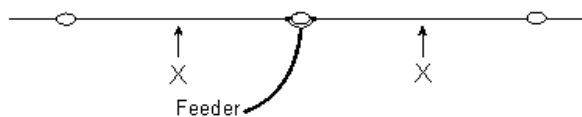

- a capacitor
- an inductor
- a fuse
- a parallel-tuned trap**

6. The physical length of the antenna shown in this diagram can be shortened and the electrical length maintained, if one of the following items is added at the points shown at 'X' in each wire:

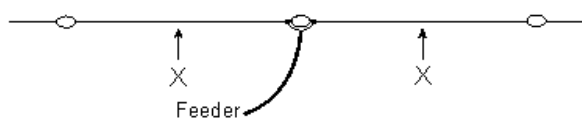

- an inductor**
- a capacitor
- an insulator
- a resistor

7. The approximate physical length of a half-wave antenna for a frequency of 1000 kHz is:

- 300 metres
- 600 metres
- 150 metres**
- 30 metres

8. The wavelength for a frequency of 25 MHz is:

- 15 metres
- 32 metres
- 4 metres
- 12 metres**

9. Magnetic and electric fields about an antenna are:

- parallel to each other
- determined by the type of antenna used
- perpendicular to each other**
- variable with the time of day

10. Radio wave polarisation is defined by the orientation of the radiated:

- a. magnetic field
- b. electric field**
- c. inductive field
- d. capacitive field

=====

11. A half wave dipole antenna is normally fed at the point of:

- a. maximum voltage
- b. maximum current**
- c. maximum resistance
- d. resonance

=====

12. An important factor to consider when high angle radiation is desired from a horizontal half-wave antenna is the:

- a. size of the antenna wire
- b. time of the year
- c. height of the antenna**
- d. mode of propagation

=====

13. An antenna which transmits equally well in all compass directions is a:

- a. dipole with a reflector only
- b. quarterwave grounded vertical**
- c. dipole with director only
- d. half-wave horizontal dipole

=====

14. A groundplane antenna emits a:

- a. horizontally polarised wave
- b. elliptically polarised wave
- c. axially polarised wave
- d. vertically polarised wave**

=====

15. The impedance at the feed point of a folded dipole antenna is approximately:

- a. 300 ohm**
- b. 150 ohm
- c. 200 ohm
- d. 100 ohm

=====

16. The centre impedance of a 'half-wave' dipole in 'free space' is approximately:

- a. 52 ohm
- b. 73 ohm**
- c. 100 ohm
- d. 150 ohm

=====

17. The effect of adding a series inductance to an antenna is to:
- increase the resonant frequency
 - have no change on the resonant frequency
 - have little effect
 - decrease the resonant frequency**
- =====
18. The purpose of a balun in a transmitting antenna system is to:
- balance harmonic radiation
 - reduce unbalanced standing waves
 - protect the antenna system from lightning strikes
 - match unbalanced and balanced transmission lines**
- =====
19. A dummy antenna:
- attenuates a signal generator to a desirable level
 - provides more selectivity when a transmitter is being tuned
 - matches an AF generator to the receiver
 - duplicates the characteristics of an antenna without radiating signals**
- =====
20. A half-wave antenna resonant at 7100 kHz is approximately this long:
- 20 metres**
 - 40 metres
 - 80 metres
 - 160 metres
- =====
21. An antenna with 20 metres of wire each side of a centre insulator will be resonant at approximately:
- 3600 kHz**
 - 3900 kHz
 - 7050 kHz
 - 7200 kHz
- =====
22. A half wave antenna cut for 7 MHz can be used on this band without change:
- 10 metre
 - 15 metre**
 - 20 metre
 - 80 metre
- =====
23. This property of an antenna broadly defines the range of frequencies to which it will be effective:
- bandwidth**
 - front-to-back ratio
 - impedance
 - polarisation
- =====

24. The resonant frequency of an antenna may be increased by:
- a. **shortening the radiating element**
 - b. lengthening the radiating element
 - c. increasing the height of the radiating element
 - d. lowering the radiating element
- =====
25. Insulators are used at the end of suspended antenna wires to:
- a. increase the effective antenna length
 - b. **limit the electrical length of the antenna**
 - c. make the antenna look more attractive
 - d. prevent any loss of radio waves by the antenna
- =====
26. To lower the resonant frequency of an antenna, the operator should:
- a. **lengthen the antenna**
 - b. centre feed the antenna with TV ribbon
 - c. shorten the antenna
 - d. ground one end
- =====
27. A half-wave antenna is often called a:
- a. bi-polar
 - b. Yagi
 - c. **dipole**
 - d. beam
- =====
28. The resonant frequency of a dipole antenna is mainly determined by:
- a. its height above the ground
 - b. **its length**
 - c. the output power of the transmitter used
 - d. the length of the transmission line
- =====
29. A transmitting antenna for 28 MHz for mounting on the roof of a car could be a:
- a. vertical long wire
 - b. **quarter wave vertical**
 - c. horizontal dipole
 - d. full wave centre fed horizontal
- =====
30. A vertical antenna which uses a flat conductive surface at its base is the:
- a. vertical dipole
 - b. **quarter wave ground plane**
 - c. rhombic
 - d. long wire
- =====

31. The main characteristic of a vertical antenna is that it:
- requires few insulators
 - is very sensitive to signals coming from horizontal aerials
 - receives signals from all points around it equally well
 - is easy to feed with TV ribbon feeder
- =====
32. At the ends of a half-wave dipole the:
- voltage and current are both high
 - voltage is high and current is low
 - voltage and current are both low
 - voltage low and current is high
- =====
33. An antenna type commonly used on HF is the:
- parabolic dish
 - cubical quad
 - 13-element Yagi
 - helical Yagi
- =====
34. A Yagi antenna is said to have a power gain over a dipole antenna for the same frequency band because:
- it radiates more power than a dipole
 - more powerful transmitters can use it
 - it concentrates the radiation in one direction
 - it can be used for more than one band
- =====
35. The maximum radiation from a three element Yagi antenna is:
- in the direction of the reflector end of the boom
 - in the direction of the director end of the boom
 - at right angles to the boom
 - parallel to the line of the coaxial feeder
- =====
36. The reflector and director(s) in a Yagi antenna are called:
- oscillators
 - tuning stubs
 - parasitic elements
 - matching units
- =====
37. An isotropic antenna is a:
- half wave reference dipole
 - infinitely long piece of wire
 - dummy load
 - hypothetical point source
- =====

38. The main reason why many VHF base and mobile antennas in amateur use are $5/8$ of a wavelength long is that:
- it is easy to match the antenna to the transmitter
 - it is a convenient length on VHF
 - the angle of radiation is high giving excellent local coverage
 - most of the energy is radiated at a low angle
- =====
39. A more important consideration when selecting an antenna for working stations at great distances is:
- sunspot activity
 - angle of radiation
 - impedance
 - bandwidth
- =====
40. On VHF and UHF bands, polarisation of the receiving antenna is important in relation to the transmitting antenna, but on HF it is relatively unimportant because:
- the ionosphere can change the polarisation of the signal from moment to moment
 - the ground wave and the sky wave continually shift the polarisation
 - anomalies in the earth's magnetic field profoundly affect HF polarisation
 - improved selectivity in HF receivers makes changes in polarisation redundant
- =====

Section 28 Propagation

The spectrum

Amateur Radio is all about the transmission of radio waves from place-to-place without wires. Signals travel from the transmitting antenna to the receiving antenna in different ways depending on the frequency used. Some frequencies use the ionosphere to bounce signals around the world while other frequencies can only be used for line-of-sight operations.

Radio waves are part of the spectrum of electromagnetic radiation, with infrared, light, ultraviolet, x-rays and cosmic rays at the extreme upper frequencies. Radio waves further subdivide into different frequency ranges. All electromagnetic radiation travels at the same speed, commonly referred to as the speed of light, $c = 3 \times 10^8$ metres per second or 300 000 km per second.

Electromagnetic radiation consists of two waves travelling together, the magnetic and the electric, with the planes of the two waves perpendicular to each other. The polarisation of a radio wave is determined by the direction of the electric field. Most antennas radiate waves that are polarised in the direction of the length of the metal radiating element. For example, the metal whips as used on cars are vertically polarised while TV antennas may be positioned for either vertical or horizontal polarisation. Polarisation is important on VHF and higher but is not very important for HF communications because the many reflections that a skywave undergoes makes its polarisation quite random.

The path

The simplest path to understand is the direct path in a straight line between transmitter and receiver. These are most important for communication on frequencies above 50 MHz. The signal might be reflected off buildings and mountains to fill in some shadows, but usually communication is just line-of-sight. On lower frequencies the ionosphere is able to reflect the radio waves. The actual direction-change in the ionosphere is closer to **refraction** but **reflection is easier to envisage**.

For simplicity, we will use the reflection word here, but remember that the mechanism is more truly refractive. Similarly, again for simplicity, we will consider the regions where the change-of-direction takes place to be "layers" although they are more strictly "regions".

The signal reflected off the ionosphere is referred to as the skywave or ionospheric wave. The groundwave is the signal that travels on the surface of the earth and depends upon the surface conductivity.

Groundwaves are the main mode of transmission on the MF bands (e.g. AM broadcast band), but they are not very important for amateur use - except

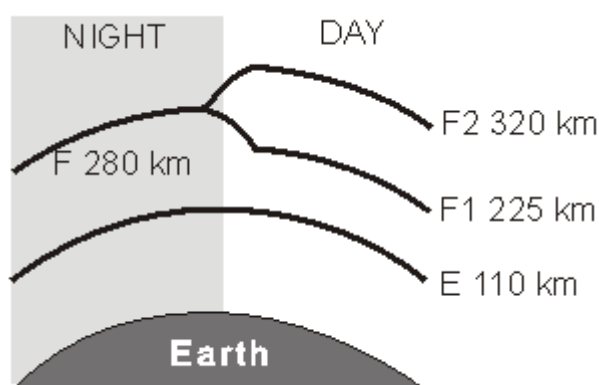

perhaps on the only amateur MF band, 160 metres, 1.8 MHz. The groundwave is usually attenuated within 100 km.

On VHF and higher frequencies, variations in the atmospheric density can bend the radio waves back down to the earth. This is referred to as the tropospheric wave.

The skywave

The skywave is the primary mode of long distance communication by radio amateurs and is usually of the most interest. A skywave will go farther if it can take longer "hops". For this reason, a low angle ($< 30^\circ$) radiation is best for DX (long distance) communication as it will travel farther before reflecting back to earth. Antennas that produce low angle radiation include verticals or dipoles mounted high (at least half a wavelength) above the ground.

The sun and the ionosphere

The ionosphere refers to the upper region of the atmosphere where charged gas molecules have been produced by the energy of the sun. The degree of ionisation varies with the intensity of the solar radiation. Various cycles affect the amount of solar radiation with the obvious ones being the daily and yearly cycles. This means that ionisation will be greatest around noon in the summer and at minimum just before dawn in the winter.

The output from the sun varies over a longer period of approximately 11 years. During the maximum of the solar sunspot cycle, there is greater solar activity and hence greater ionisation of the ionosphere.

Greater solar activity generally results in better conditions for radio propagation by increasing ionisation. However, very intense activity in the form of geomagnetic storms triggered by a solar flare can completely disrupt the layer of the ionosphere and block communications. This can happen in minutes and communications can take hours to recover.

Ionospheric layers

The ionosphere is not a homogenous region but consists of rather distinct layers or regions which have their own individual effects on radio propagation. The layers of distinct interest to radio amateurs are the E and F layers.

The E layer at about 110 km is the lower of the two. It is in the denser region of the atmosphere where the ions formed by solar energy recombine quickly. This means the layer is densest at noon and dissipates quickly when the sun goes down.

The F layer is higher and during the day separates into two layers, F1 and F2 at about 225 and 320 km. It merges at night to form a single F layer at about 280 km.

The different layer of the ionosphere can reflect radio waves back down to earth which in turn can reflect the signal back up again. A signal can "hop" around the world in this way. The higher the layer, the longer the hop. The longer the hop the better since some of the signal's energy is lost at each hop.

Lower angle radiation will go farther before it reflects off the ionosphere. So to achieve greatest DX, one tries to choose a frequency that will reflect off the highest layer possible and use the lowest angle of radiation. The distance covered in one hop is the skip distance. For destinations beyond the maximum skip distance the signal must make multiple hops.

The virtual height of any ionospheric layer at any time can be determined using an ionospheric sounder or ionosonde, in effect a vertical radar. This sends pulses that sweep over a wide frequency range straight up into the ionosphere. The echoes returned are timed (for distance) and recorded. A plot of frequency against height can be produced. The highest frequency that returns echoes at vertical incidence is known as the **critical frequency**.

Absorption

The ionosphere can also absorb radio waves as well as reflect them. The absorption is greater at lower frequencies and with denser ionisation. There is another layer of ionisation below the E layer, called the D layer, which only exists during the day. It will absorb almost all signals below 4 MHz - i.e. the 80 and 160 metre bands. Short-range communication is still possible using higher angle radiation which is less affected. It travels a shorter distance through the atmosphere. The signal can then reflect off the E layer to the receiver. The D and E layers are responsible for you hearing only local AM broadcast stations during the day and more distant ones at night.

Attenuation

The attenuation of a signal by the ionosphere is higher at lower frequencies. So for greater distance communication one should use higher frequencies. But if the frequency used is too high, the signal will pass into space and not reflect back to earth. This may be good for satellite operation but is not useful for HF DX working.

For DX working on HF, one should try to use the highest frequency that will still reflect off the ionosphere. This varies with solar activity and time of day. It can be calculated with various formulas given the current solar indices. This frequency is referred to as the Maximum Usable Frequency (MUF). In the peak of the solar cycle it can often be over 30 MHz and on rare occasions up to 50 MHz. At other times, during the night, it can drop below 10 MHz.

At the low end of the spectrum, daytime absorption by the D layer limits the possible range. In addition, atmospheric noise is greater and limits the Lowest Usable Frequency (LUF). This noise and absorption decreases at night lowering the LUF at the same time as the MUF is lowered by the decrease in solar excitation of the ionosphere. This usually means that by picking the right frequency, long range communication is possible at any time.

Fading

Radio waves can travel over different paths from transmitter to receiver. If a path length varies by a multiple of half the wavelength of the signal, the signals arriving by two or more paths may completely cancel each other. This multi-path action causes fading of the signal. Other phenomena can cause this. Aircraft, mountains and ionospheric layers can reflect part of a signal while another part takes a more direct path.

Sometimes fading may be so frequency-dependent that one sideband of a double-sideband (AM) signal may be completely unreadable while the other is "good copy". This is known as "selective fading". It will often be observed just as a band is on the verge of closing, when reflections from two layers are received simultaneously.

Fading can also occur when a signal passes through the polar regions, referred to as polar flutter, caused by different phenomena. The ionosphere is much more disorganised in the polar regions because of the interaction of solar energy with the geomagnetic field. The same phenomena that cause aurora can cause the wavering of signals on polar paths.

Other atmospheric effects

Other atmospheric effects can affect radio propagation and may often extend the transmission of VHF and higher signals beyond the line-of-sight. The lowest region in the atmosphere, the troposphere, can scatter VHF signals more than 600 km - tropospheric scatter. Ducting is a phenomenon where radio waves get trapped by a variation in the atmospheric density. The waves can then travel along by refraction. Ducting usually occurs over water or other homogenous surfaces. This is more common at higher frequencies and has permitted UHF communication over distances greater than 2500 km.

Another phenomenon, sporadic E skip, is a seasonal occurrence, usually during the summer. A small region of the E layer becomes more highly charged than usual, permitting the reflection of signals as high in frequency as 200 MHz. This highly-charged region soon dissipates. Sporadic E propagation will occur for only a few minutes to a few hours.

Communication can be achieved by bouncing signals off the ionised trails of meteors. Meteor scatter communication may only last a few seconds so it is feasible only when large numbers of meteors enter the atmosphere, particularly during times of meteor showers.

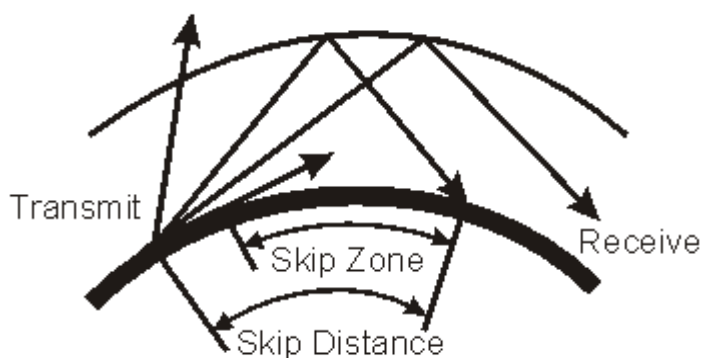

Skip zone

Amateurs are usually concerned about working to the maximum possible distances but there are times when one can talk to people thousands of kilometres away but cannot talk to someone only 500 km away. A skip zone can be created by the ionosphere reflecting signals from a shallow angle. Waves at a higher angle pass directly

through and are lost into space. The critical angle varies with the degree of ionisation and generally results in larger skip zones at night. The area between the limit of maximum range by direct wave or ground wave, and the maximum skip distance by skywave is known as the skip zone.

Question File: 28. Propagation: (5 questions)

1. A 'skip zone' is:
- the distance between the antenna and where the refracted wave first returns to earth
 - the distance between the far end of the ground wave and where the refracted wave first returns to earth
 - the distance between any two refracted waves
 - a zone caused by lost sky waves

- =====
2. The medium which reflects high frequency radio waves back to the earth's surface is called the:
- biosphere
 - stratosphere
 - ionosphere
 - troposphere

- =====
3. The highest frequency that will be reflected back to the earth at any given time is known as the:
- UHF
 - MUF
 - OWF
 - LUF

- =====
4. All communications frequencies throughout the spectrum are affected in varying degrees by the:
- atmospheric conditions
 - ionosphere
 - aurora borealis
 - sun

- =====
5. Solar cycles have an average length of:
- 1 year
 - 3 years
 - 6 years
 - 11 years

- =====
6. The 'skywave' is another name for the:
- ionospheric wave
 - tropospheric wave
 - ground wave
 - inverted wave
- =====

7. The polarisation of an electromagnetic wave is defined by the direction of:
- the H field
 - propagation
 - the E field**
 - the receiving antenna
- =====
8. That portion of HF radiation which is directly affected by the surface of the earth is called:
- ionospheric wave
 - local field wave
 - ground wave**
 - inverted wave
- =====
9. Radio wave energy on frequencies below 4 MHz during daylight hours is almost completely absorbed by this ionospheric layer:
- C
 - D**
 - E
 - F
- =====
10. Because of high absorption levels at frequencies below 4 MHz during daylight hours, only high angle signals are normally reflected back by this layer:
- C
 - D
 - E**
 - F
- =====
11. Scattered patches of high ionisation developed seasonally at the height of one of the layers is called:
- sporadic-E**
 - patchy
 - random reflectors
 - trans-equatorial ionisation
- =====
12. For long distance propagation, the radiation angle of energy from the antenna should be:
- less than 30 degrees**
 - more than 30 degrees but less than forty-five
 - more than 45 degrees but less than ninety
 - 90 degrees
- =====

13. The path radio waves normally follow from a transmitting antenna to a receiving antenna at VHF and higher frequencies is a:
- circular path going north or south from the transmitter
 - great circle path
 - straight line**
 - bent path via the ionosphere
- =====
14. A radio wave may follow two or more different paths during propagation and produce slowly-changing phase differences between signals at the receiver resulting in a phenomenon called:
- absorption
 - baffling
 - fading**
 - skip
- =====
15. The distance from the far end of the ground wave to the nearest point where the sky wave returns to the earth is called the:
- skip distance
 - radiation distance
 - skip angle
 - skip zone**
- =====
16. High Frequency long-distance propagation is most dependent on:
- ionospheric reflection**
 - tropospheric reflection
 - ground reflection
 - inverted reflection
- =====
17. The layer of the ionosphere mainly responsible for long distance communication is:
- C
 - D
 - E
 - F**
- =====
18. The ionisation level of the ionosphere reaches its minimum:
- just after sunset
 - just before sunrise**
 - at noon
 - at midnight
- =====
19. One of the ionospheric layers splits into two parts during the day called:
- A & B
 - D1 & D2
 - E1 & E2
 - F1 & F2**
- =====
20. Signal fadeouts resulting from an 'ionospheric storm' or 'sudden ionospheric disturbance' are usually attributed to:
- heating of the ionised layers

- b. over-use of the signal path
- c. insufficient transmitted power
- d. solar flare activity

- =====
21. The 80 metre band is useful for working:
- a. in the summer at midday during high sunspot activity
 - b. long distance during daylight hours when absorption is not significant
 - c. all points on the earth's surface
 - d. up to several thousand kilometres in darkness but atmospheric and man-made noises tend to be high

- =====
22. The skip distance of radio signals is determined by the:
- a. type of transmitting antenna used
 - b. power fed to the final amplifier of the transmitter
 - c. only the angle of radiation from the antenna
 - d. both the height of the ionosphere and the angle of radiation from the antenna

- =====
23. Three recognised layers of the ionosphere that affect radio propagation are:
- a. A, E, F
 - b. B, D, E
 - c. C, E, F
 - d. D, E, F

- =====
24. Propagation on 80 metres during the summer daylight hours is limited to relatively short distances because of
- a. high absorption in the D layer
 - b. the disappearance of the E layer
 - c. poor refraction by the F layer
 - d. pollution in the T layer

- =====
25. The distance from the transmitter to the nearest point where the sky wave returns to the earth is called the:
- a. angle of radiation
 - b. maximum usable frequency
 - c. skip distance
 - d. skip zone

- =====
26. A variation in received signal strength caused by slowly changing differences in path lengths is called:
- a. absorption
 - b. fading
 - c. fluctuation
 - d. path loss
- =====

27. VHF and UHF bands are frequently used for satellite communication because:
- waves at these frequencies travel to and from the satellite relatively unaffected by the ionosphere
 - the Doppler frequency change caused by satellite motion is much less than at HF
 - satellites move too fast for HF waves to follow
 - the Doppler effect would cause HF waves to be shifted into the VHF and UHF bands.

- =====
 28. The 'critical frequency' is defined as the:
- highest frequency to which your transmitter can be tuned
 - lowest frequency which is reflected back to earth at vertical incidence
 - minimum usable frequency
 - highest frequency which will be reflected back to earth at vertical incidence

- =====
 29. The speed of a radio wave:
- varies indirectly to the frequency
 - is the same as the speed of light
 - is infinite in space
 - is always less than half the speed of light

- =====
 30. The MUF for a given radio path is the:
- mean of the maximum and minimum usable frequencies
 - maximum usable frequency
 - minimum usable frequency
 - mandatory usable frequency

- =====
 31. The position of the E layer in the ionosphere is:
- above the F layer
 - below the F layer
 - below the D layer
 - sporadic

- =====
 32. A distant amplitude-modulated station is heard quite loudly but the modulation is at times severely distorted. A similar local station is not affected. The probable cause of this is:
- transmitter malfunction
 - selective fading
 - a sudden ionospheric disturbance
 - front end overload

- =====
 33. Skip distance is a term associated with signals through the ionosphere. Skip effects are due to:
- reflection and refraction from the ionosphere
 - selective fading of local signals
 - high gain antennas being used
 - local cloud cover

34. The type of atmospheric layers which will best return signals to earth are:
- a. oxidised layers
 - b. heavy cloud layers
 - c. ionised layers
 - d. sun spot layers
- =====

35. The ionosphere:
- a. is a magnetised belt around the earth
 - b. consists of magnetised particles around the earth
 - c. is formed from layers of ionised gases around the earth
 - d. is a spherical belt of solar radiation around the earth
- =====

36. The skip distance of a sky wave will be greatest when the:
- a. ionosphere is most densely ionised
 - b. signal given out is strongest
 - c. angle of radiation is smallest
 - d. polarisation is vertical
- =====

37. If the height of the reflecting layer of the ionosphere increases, the skip distance of a high frequency transmission:
- a. stays the same
 - b. decreases
 - c. varies regularly
 - d. becomes greater
- =====

38. If the frequency of a transmitted signal is so high that we no longer receive a reflection from the ionosphere, the signal frequency is above the:
- a. speed of light
 - b. sun spot frequency
 - c. skip distance
 - d. maximum usable frequency
- =====

39. A 'line of sight' transmission between two stations uses mainly the:
- a. ionosphere
 - b. troposphere
 - c. sky wave
 - d. ground wave
- =====

40. The distance travelled by ground waves in air:
- a. is the same for all frequencies
 - b. is less at higher frequencies
 - c. is more at higher frequencies
 - d. depends on the maximum usable frequency
- =====

41. The radio wave from the transmitter to the ionosphere and back to earth is correctly known as the:
- a. sky wave
 - b. skip wave
 - c. surface wave
 - d. F layer
- =====
42. Reception of high frequency radio waves beyond 4000 km normally occurs by the:
- a. ground wave
 - b. skip wave
 - c. surface wave
 - d. sky wave
- =====
43. A 28 MHz radio signal is more likely to be heard over great distances:
- a. if the transmitter power is reduced
 - b. during daylight hours
 - c. only during the night
 - d. at full moon
- =====
44. The number of high frequency bands open to long distance communication at any time depends on:
- a. the highest frequency at which ionospheric reflection can occur
 - b. the number of frequencies the receiver can tune
 - c. the power being radiated by the transmitting station
 - d. the height of the transmitting antenna
- =====
45. Regular changes in the ionosphere occur approximately every 11:
- a. days
 - b. months
 - c. years
 - d. centuries
- =====
46. When a HF transmitted radio signal reaches a receiver, small changes in the ionosphere can cause:
- a. consistently stronger signals
 - b. a change in the ground wave signal
 - c. variations in signal strength
 - d. consistently weaker signals
- =====
47. The usual effect of ionospheric storms is to:
- a. increase the maximum usable frequency
 - b. cause a fade-out of sky-wave signals
 - c. produce extreme weather changes
 - d. prevent communications by ground wave
- =====

48. Changes in received signal strength when sky wave propagation is used are called:
- a. ground wave losses
 - b. modulation losses
 - c. fading
 - d. sunspots
- =====
49. Although high frequency signals may be received from a distant station by a sky wave at a certain time, it may not be possible to hear them an hour later. This may be due to:
- a. changes in the ionosphere
 - b. shading of the earth by clouds
 - c. changes in atmospheric temperature
 - d. absorption of the ground wave signal
- =====
50. VHF or UHF signals transmitted towards a tall building are often received at a more distant point in another direction because:
- a. these waves are easily bent by the ionosphere
 - b. these waves are easily reflected by objects in their path
 - c. you can never tell in which direction a wave is travelling
 - d. tall buildings have elevators
- =====

Section 29 Interference and Filtering

Filters

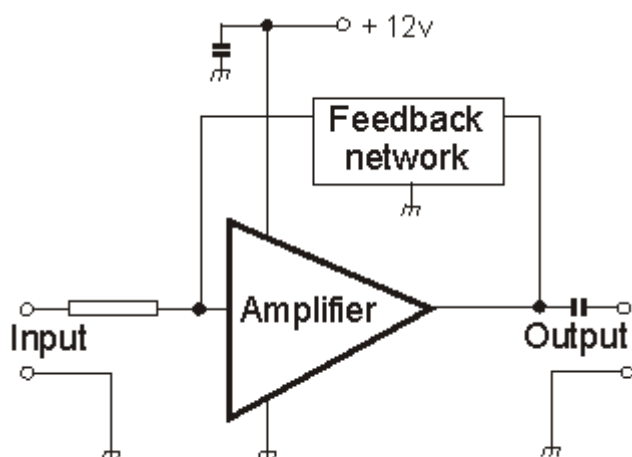

Filters can be active or passive. Passive filters, comprised of inductors and capacitors, are used for the suppression of unwanted signals and interference. These are treated below.

Active filters use amplifying devices such as transistors or integrated circuits with feedback applied to achieve the required filter characteristics.

The "operational amplifier" is one such active device with features making it particularly suitable for filter applications up to a few megahertz. This diagram shows a typical example.

These can have a very high gain but with negative feedback applied, are usually operated to produce a circuit with unity gain. The input impedance to such a circuit can be very high. These circuits are compact, and able to have variable Q, centre, and cut-off frequencies. The circuit gain and performance can be adjusted by changes to the feedback network.

Key clicks

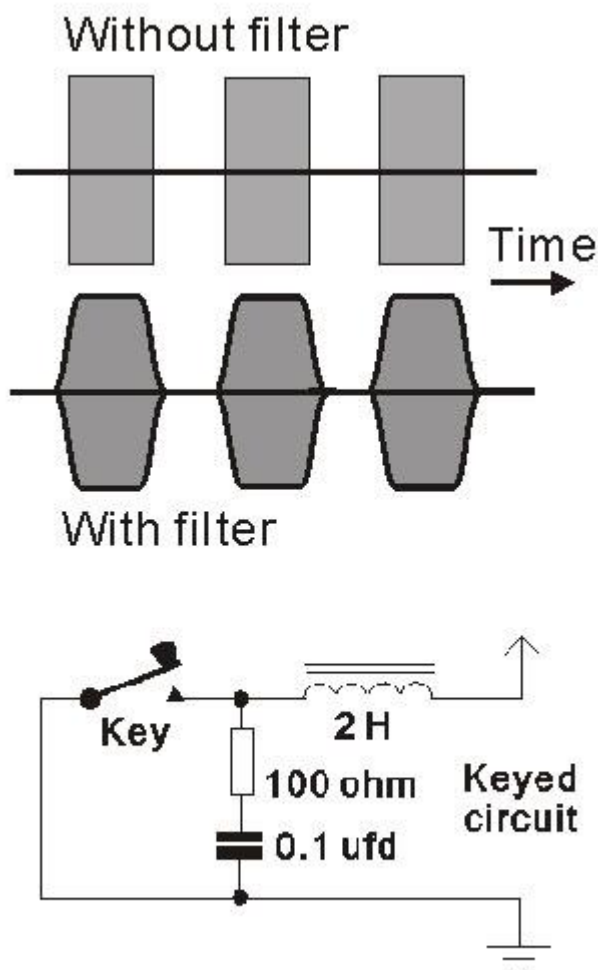

In a CW transmission, the envelope of the keyed RF output waveform may be as shown in this upper diagram - a square-wave. When analysed this will be found to be composed of a large number of sinewaves.

These sidebands may extend over an wide part of the adjacent band and be annoying to listeners - a form of click or thud each time your key is operated.

To prevent this happening, the high-frequency components of the keying waveform must be attenuated. In practice this means preventing any sudden changes in the amplitude of the RF signal. With suitable shaping, it is possible to produce an envelope waveform as shown in the lower diagram.

One means for doing this is a key-click filter as shown in this diagram. When the key contacts close, the inductance of the iron-cored choke prevents the key current from rising too suddenly. When the contacts are broken, the capacitor

keeps the keyed current going for a short period. The resistor prevents the discharge current from being excessive.

Note that the body of the key is at earth potential at all times - for safety reasons.

Interference

Radio transmissions can cause interference to other Radio Services and to nearby electronic equipment. Some Radio Frequency Interference (RFI) can render some equipment completely useless.

The term "Electromagnetic Compatibility" (EMC), is the preferred title and reflects the need for all devices to co-exist together in the same electromagnetic environment.

The responsibility for avoidance of, and the suppression of, interference to other Radio Services, is a Radio Regulatory matter is considered in the section on Regulations

This *Interference and Filtering* section will consider the causes of and solutions to common RFI problems - problems that arise when your transmitted signal "gets into" your own and other television receivers and other appliances.

It is important, for domestic and for neighbourhood harmony, to be able to correct manufacturing deficiencies in consumer electronics.

Filter passbands

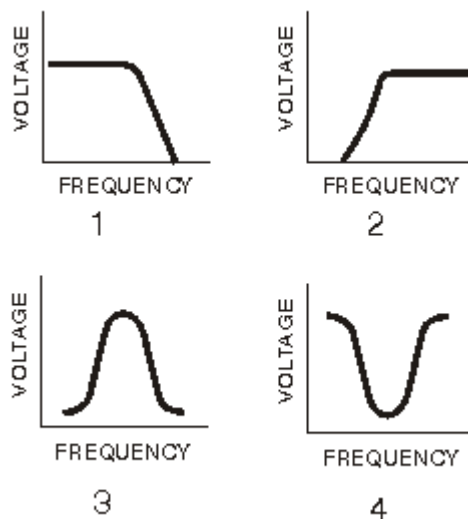

Filters form the basis of many RFI circuits. A filter is a frequency-selective circuit which passes signals of certain frequencies while attenuating others. Filters are able to select desired frequencies from undesired frequencies so they are fundamental to suppressing interference.

Typical measures of a filter are its cut-off frequency and its Q.

The cut-off frequency is defined as the frequency at which the signal will be reduced to half the power of the maximum signal passed. The Q (or quality) of a filter is a measure of how "sharp" the filter is. High-Q

filters are those with a relatively narrow bandwidth, while low-Q filters have a relatively wide bandwidth. A filter's bandwidth is the frequency separation between cut-off frequencies.

This diagram shows the four common filter types. They are easy to recognise.

Low Pass filters exhibit the typical characteristic shown in **1**.
High Pass is shown in **2**.
Band Pass is shown in **3**.
Band Stop in **4**.

These diagrams are for demonstration only. Practical filters exhibit considerable differences and more pronounced characteristics.

Broadcast and Television Interference

TV interference is of two types -

TV receivers which radiate spurious emissions and cause interference to the signals **you** are trying to receive on the amateur bands, and

interference which **your** transmissions cause to TV reception on adjacent television receivers.

It is the second variety that is the more important and the more difficult.

The text following is based on the NZART document: "**A Code of Practice for Radio and Television Interference Cases**" dated 1981, published in "Break-In" October 1981.

A copy of the original document can be obtained from NZART Headquarters, P.O. Box 40-525, Upper Hutt or at <mailto:nzart@clear.net.nz> . Please give this reference to the month and year of this "Break-In" issue and your postal address.

A Code of Practice for Radio and Television Interference Cases

1. Introduction

This is a guide for radio amateurs whose operations come to the attention of neighbours through disturbance to reception of sound broadcast and television transmissions (BCI and TVI). This disturbance is a continuing risk in amateur radio, and all radio amateurs can expect to cause or to be accused of causing BCI or TVI at some time. The interference is not damaging and the accusation does not bring any disgrace.

Interference between one radio service and another is inevitable from time to time, because all services share the one radio frequency spectrum.

You must face the problem only when it arises, and you should not worry about it beforehand. You should not fear a TVI or BCI report in any way or restrict your activities or hours of operation because a report may arise.

The best advice is this: ensure that the apparatus in your own home is free from interference caused by your amateur radio activities--and be active on the air. In

all cases of interference, a cure is possible. Problems can be cured only as they arise. In reading this guide, which treats TVI in greater detail, bear in mind that in BCI cases you must take a similar approach.

The exact procedure to follow in interference cases cannot be laid down. Each case differs. Neighbours have been known to complain of interference after a radio amateur has erected a new aerial but before it has been used for transmitting. In other cases, neighbours have tolerated overhearing transmissions because they like to feel informed. Few hard and-fast rules can be offered.

2. BCI

Interference to broadcast-band receivers is often reported. The broadcast receiver cannot be considered to be of adequate design unless it has a radio-frequency amplifier stage and is connected to an outside aerial. An internal aerial or an aerial in the same room as the receiver is not to be accepted as satisfactory.

The amateur's transmissions may be able to be received at various points on the tuning dial, but the generally-accepted rule is that the case is one of interference only when reception of the local broadcast stations is disturbed.

3. Interference to audio devices

By some reports, an amateur's transmissions are heard from record players, stereo grams, and similar audio devices that are not designed for the reception of radio transmissions.

On receiving a report of interference to such an audio device, courteously discuss the matter with the owner, and advise him to contact the supplier or his supplier's agent to arrange for it to receive attention and to have the deficiency cured. These devices are not designed to be radio receivers.

4. TVI

The important point to remember about TVI is that it can be cured. Bear this point in mind at all times. TVI must be challenged head-on and a cure found for each separate case. Unfortunately, there may be no easy way or shortcut.

5 Preliminaries

When you start transmitting from a new neighbourhood or with a new rig, first ensure that your own television set is absolutely free from TVI. Then operate without any self-imposed restrictions of any sort. That is, operate when you want to, for as long as you wish, on any authorised band, with any power up to your legal limit, and with no disturbance to your own television receiver.

A radio amateur's first operating concern should be to ensure that the television receiver in his own home is disturbance-free. It should not display any interference when operation is taking place on the frequented amateur bands.

Your television receiver is very close to the transmitter and its aerial. Having your TV receiver "clean" is important for several reasons, the first being that it promotes domestic or family harmony! Your receiver will be the subject of the first tests the MED RSM Official may want to make--and revealing a clean display on your own television set will incline him in your favour. Revealing a clean set can also help you to deal with neighbours who do not believe that the fault lies in their own installation. If your own TV set is not TVI free, therefore you should make it so!

6. The wait

Do not ask the neighbours for TVI reports. Let the neighbours first report the matter either to yourself or to the MED RSM. Wait for the TVI reports (if any) to come to you-- they may never come.

7 . Reports

TVI reports can come from several directions and in several ways.

The neighbour may contact you or a member of your family. An MED RSM Official may contact you. The report may be very complete, may be garbled or incomplete, may be casual, or may be second or third hand. Be sure you recognise a TVI report as such, and note it well.

8. Action upon receiving a report

- a. Do not delay. Attend to the matter promptly.
- b. Check what you learn against your own operating activities and against your log. Have you changed bands, changed aerials, or built a new amplifier? Does the report coincide with changes to your installation or operating habits?
- c. Check that any interference is in fact due to you. Be sure that it is not from a neighbour's new electric drill, arc welder, or other appliance, or from some other source.
- d. Check with family members who view your own television set. Was any interference observed at the time claimed?
- e. Show concern, but do not admit any responsibility for the interference at this stage. Wait until tests have been conducted.
- f. Determine whether the MED RSM staff have or have not been notified.

g. Get full details of the interference, the time, the channel, and the nature of the interference on picture and on the sound. Has it just started, or is the problem of long standing?

h. Details of the model or type of television receiver, feeder, and aerial are also useful.

i. Start a notebook with date, time, and details of the report. Because even cases with big problems have small beginnings, start an accurate record early. You cannot be sure of the final outcome.

j. Above all don't worry.

9. When should you contact the MED RSM?

This depends on the nature of the TVI report reaching you, the degree of co-operation shown by the neighbours, and how well you know them. If the neighbour directs threats or abuse at you, or is not known to you, or claims that the fault is wholly yours, do not hesitate to notify the MED RSM by telephone.

You would be wise to be prepared to give a short history of any previous TVI problems you have experienced in this same location. Have you cured similar problems? This is where the notebook becomes useful.

If you do not show any TVI on your own set, continue to operate until the matter can be investigated.

If your neighbour is co-operative and is prepared to let you or a friend examine the set; then offer to do some tests to try to reproduce the conditions that gave rise to the interference. You may be able to cure the problem without involving the MED RSM staff at all.

Please be aware that the MED RSM may charge someone for their services. Make enquiries first to determine any costs involved and where their account is likely to be directed. This may depend on where the source of the interference is finally found.

10. The cause

The technical mechanism or whatever generates the interference or disturbance must be established early to determine:

- a. The cure necessary, and,
- b. Who is responsible for affecting a cure, and,
- c. Who is to pay any expenses involved.

Because tests must be carried out to determine this mechanism, the following are necessary:

- a. Access to the television set for tests,
- b. Operation of the transmitting equipment, and,
- c. Someone with TVI tracing experience to decide which tests should be done, to carry out the tests, and to interpret the results.

This means that the radio amateur and the neighbour must be present for the period of the tests. That is, co-operation is necessary.

The tests may or may not be conducted by the MED RSM. They could be conducted by some other competent person provided the co-operation of the neighbour is assured.

Note that one or more mechanisms may be creating the interference, and so more than one cure may be necessary at any television installation. At any one transmitter site, the disturbance in adjacent television receivers may be generated by quite different mechanisms.

11. The problems

The two problems that arise with TVI are:

- a. Technical, and,
- b. Social.

Few people will comment on which is the more difficult! The technical cause may be:

- a. At the transmitter installation, or,
- b. At the receiver installation, or,
- c. Somewhere else, or,
- d. Combinations of these.

12. The tests

The first tests should be elementary:

- a. Check the TV installation. Is the aerial in good order? Is it installed in accordance with accepted practice? Is the ribbon / coax in good order? Is a balun fitted? Is the aerial adequate for the TV field strength at the site? Is the aerial suitable for the TV channels received at the site? Check the suitability of the aerial mount. Check the joints between feeder and aerial elements. Do not

assume that because a television aerial has been commercially installed that it will have been correctly installed. The requirements of a TV aerial to reject interference are more stringent than those for satisfactory reception when interference is absent. An aerial which gives satisfactory reception when installed may prove inadequate later when a source of interference comes into being.

b. Have another operator work the transmitter on the frequency from which interference is suspected. Note any disturbance to picture, colour, or sound. Make adjustments to accessible controls - fine tuning, contrast, and colour. Check all television channels. A VHF link to the transmitter operator is useful for co-ordination

c. Substitute another television receiver (perhaps a different model) and repeat the tests. Use a television set known to be TVI-free in a similar location.

d. Do not remove the back from the television set. Confine tests to operational tests, intended only to identify the nature of the disturbance, but try a high-pass filter (if available) in the television aerial lead if a quick diagnosis decides that this might help, if the neighbour agrees.

e. Obtain details of the set's make and model. Is it under guarantee? How old is it? Who supplied it? Is it under a service contract? Who maintains it? Is it a rental set?

f. Has an official from the MED RSM viewed the set? Does the MED RSM know of the problem ?

g. Keep the test short, make no promises, and do not give an opinion at the site. Withdraw, consult textbooks and other persons for advice, and then decide on a course of action.

13. The rusty-bolt effect

High-pass filters (at the television receiver aerial terminals) and low-pass filters (at the transmitter) do not always cure TVI problems. Substitution of other TV sets can generally show if the cause is a faulty transmitter or faulty television receiver, but if substitution shows the interference effect to continue, then the cause becomes more difficult to establish. The "rusty-bolt" effect is one of the hardest of all these TVI causes to locate.

If a known clean transmitter is causing interference to a known good television receiver, then an external cause can be suspected. Perhaps the transmitter signal is being picked up by a local conductor such as a clothes-line or fence-wire. A rusty or corroded joint in this conductor may be acting as a diode. Harmonics of the transmitter signal could be produced by this spurious diode detector and re-radiated. These harmonics can be received by the television receiver and cause interference to the picture or sound.

Such interference may vary with the weather. It may be intermittent and be affected by wind as well as rain.

Typical offenders are metal-tile roofs, metal gutters and down pipes. A heavy blow with a hammer may sometimes correct an offending joint. Applying water from a hose can sometimes change or remove the interfering source and help to identify the culprit.

Either bonding or insulating the offending joint may solve the problem. More than one joint may be causing trouble. Bonding is generally impossible with metal tiles. Shifting the television aerial away from the offending harmonic source or sources is a more practical cure. A bonded wire mesh over the offending joint may be considered. It is unlikely that a complete metal roof will have to be bonded to effect a cure.

Bonding suspect joints can sometimes produce problems. With bonded conductors, a better signal pick-up may result, larger radio frequency currents may flow, and the problem may shift to another joint that was hitherto not suspect. Insulating the suspect joints may sometimes be more effective. A change to nylon guy-wires may sometimes eliminate problem joints.

The accepted rule is that if the offending joints are on the amateur's property, the problem is his. If the offending joints are on the property of the television set's owner the problem is his, Unfortunately, few set-owners understand this problem and so the radio amateur should offer technical assistance and advice. Re-siting the television set aerial or the transmitting aerial is often the only practicable cure.

14. Guarantees and service contracts

If the television set has been shown to be faulty and is under a guarantee or a service contract, then give the firm concerned early advice of the problem. This is best done after the MED RSM has been advised and the problem discussed. Advise the firm concerned that the MED RSM is aware of the problem. These actions are really the concern of the television set's owner, but the radio amateur may offer to assist.

15. Rental sets

Rental sets should be treated in the same way as a set with a service contract. A rental set has the advantage that a change to another model may be possible, which could cure an otherwise difficult problem.

16. Getting involved with other people's gear

As a radio amateur, you should be aware of the undesirability of agreeing to fix a neighbour's equipment. The equipment may be under guarantee, may be covered by a service contract, or may be rented. It may not belong to the person who is using it, who may not always be honest and forthright about ownership. Where to draw the line depends very much on how well you know the neighbour, and other factors, such as the age of the set, and the nature of the problem itself.

Your "unauthorised tampering" may invalidate guarantees and service contracts. Future problems with the equipment - in no way related to the interference problem - will without doubt be blamed on the radio amateur. No radio amateur wants to be concerned with the maintenance of his neighbour's equipment for evermore. The possibility of double-blame must be avoided (first the interference, and then of damaging the set).

Safety and Regulations are good reasons for keeping out of a neighbour's set. Many modern television receivers may operate with the chassis alive - at about half mains voltage. This also means that short lengths of coaxial cable inside the set (to the aerial isolation unit) could appear to have the outer at earth potential, but in fact this outer could be at a hazardous potential. Under the various Electrical Acts and Electrical Regulations, a radio amateur is not qualified to service mains-operated television receivers.

17. What level of interference is tolerable?

Slight disturbances on a television test pattern which are barely noticed by a trained eye will not be seen on a television picture.

Disturbances of the same level as the noise on the picture, and less than interference from motor vehicle ignition, electrical appliance noise or aircraft flutter, are acceptable.

Tearing of the picture, herringbones, or switching between colour and black and white are unacceptable.

The last trace of TVI may be slight changes at the areas of intense red in a picture. This is acceptable for unless attention is drawn to it, it will be unnoticed.

Noises from an adjacent transmitter should not be heard during pauses in the television sound.

It is wise not to draw the attention of the owner to minor disturbances. Instead, check if he is satisfied with the quality of reception. The neighbour should be unable to tell when you are transmitting.

18. Contact with the equipment manufacturer

Where substitution of another set or other tests have shown that the fault is within a particular television receiver or other piece of commercial equipment, consider approaching the manufacturer of the equipment. When or how this should be done depends on the attitude of the local agent for the equipment, and the status of the guarantee or service contract. Ideally, the local supplier of the equipment should handle communications with the manufacturer in cases where a manufacturer's modification or the expense of a local modification arises. Again the radio amateur may offer to assist the owner.

If you approach a manufacturer, be certain to include details of model type and serial numbers, age of set, installation arrangements, tests conducted and their results, and any other details that will help in an analysis of the problem, diagnosis of its cause, and the development of a cure.

19. The radio amateur's responsibility for the cure

The radio amateur should accept responsibility for being the cause of TVI, only if carefully conducted tests have established:

- a. That his transmitting installation is faulty, or,
- b. That, in the substitution of another transmitter of comparable characteristics, the problem disappears, or,
- c. That, in more than one adjacent television set, previously TVI-free, the same interference symptoms suddenly appear at the same time, and coincide with transmissions from the amateur's transmitter, or,
- d. That a parasitic rectifying joint on the radio amateur's own premises is generating interfering signal components.

20. The television set owner's responsibility for the cure.

The owner or user of the television set must accept responsibility for curing the interference if carefully conducted tests show:

- a. That no interference is exhibited on the radio amateur's own television receiver on the radio amateur's own premises, or,
- b. That a high-pass filter or other trap device on the television aerial eliminates the interference, or,
- c. That any parasitic rectifying junction is shown to be located on the property of the television set's owner or user, or,
- d. That another television receiver substituted at the television installation fails to display the same interference, or,
- e. That other attention at the television installation will cure the interference; for example, repairs to the aerial or feeder, or a shift of the television aerial to another position.

22. The viewers' choice

If a television viewer chooses to view television programmes on a defective set, or a set with a defective installation, he should not expect a radio amateur to cease transmissions to remove the disturbances to his viewing.

25. Terminology

Be careful with the use of words. An amateur transmitter does not "interfere with" or "cause interference" to television reception until properly conducted tests have clearly established that the fault is in the transmitting equipment or the transmitting installation.

A properly adjusted transmitter, radiating a "clean" signal, does not "radiate interference" or "cause interference". Disturbances to television reception should not be described as "interference" if the television set has deficiencies in its design or installation that cause it to respond to signals from a "clean" transmitter.

A faulty television receiver or installation that responds to the amateur transmitter's "clean" signal does not exhibit "interference" - although this is the term often given to it (TVI). "Reception is being disturbed" is a better description.

If the transmitter is faulty and radiates energy that enters the television set at the television channel frequencies, then this is clearly a case of "interference". The amateur transmitter is then "radiating an interfering signal".

If the fault is at the television receiver, and the transmitter is blameless, then the transmitter cannot be said to be "causing interference".

26. The approach

Be tactful when explaining to a neighbour that his television receiver or installation is faulty. An explanation such as follows is satisfactory and typical:

"You have a very good set. It displays each channel very well, with good crisp pictures and pleasant sound. Unfortunately, it also responds to signals not meant for it, and this means it is defective. Other sets in the area are known to be unaffected in this way ... By means of some tests, we can determine if the fault is inside the set, or if it can be cured by changes to your aerial, or if your installation needs a filter or trap added to the aerial lead." The punch line "it also responds to signals not meant for it, and this means it is defective should be carefully explained.

Contact with the neighbours may be by a visit, telephone, or a formal letter. The procedure to adopt depends how approachable they are, how well you know them, and where the TVI report came from, and how it was conveyed to you. There is a need to explain to the layman what Radio Frequency Interference (RFI) is, and what radio amateurs do.

27. No guarantees possible for TVI cures

The possibility of a TVI report is ever present. Once a cure has been effected to a TVI case, there is no known way of ensuring that the same set will not again become subject to TVI at some later time, perhaps by other cause. Damage and corrosion takes its toll of aerials and earthing systems.

Sets age and become faulty. The radio frequency spectrum is a shared resource, and until we have new knowledge or techniques, all radio amateurs must learn to

live with the possibility of a TVI case arising at any time and be trained in how to handle it when it does arise.

A radio amateur should not, and can not, give a neighbour a guarantee that a TVI cure just made will remain effective for any period.

28. Fitting devices to a neighbour's set

It may be found that a high-pass filter, traps, stubs or other device fitted at the aerial terminals of a neighbour's TV set will cure disturbances to his viewing. It is important to leave a label or tag securely attached to the set, which gives reason for the installation of the device - otherwise the device may be removed by someone in the absence of an interfering signal "because it has no effect"!

29. Extra assistance

Every NZART Branch should designate a member of its Committee as Interference Officer, his duties being to receive requests for assistance on BCI / TVI matters from members. He should have power to enlist other technically qualified members of the Branch into a team to help any member who needs tests, diagnosis, negotiations, advice, and other support until the case is closed. Amateurs should be seen to be united - this is important.

An independent expert third party may be acceptable to a neighbour in difficult cases.

Branches should be aware that the NZART Council is in a position to help with problem BCI / TVI cases, particularly where added technical assistance is required, or where an amateur is under pressure from a local dignitary or influential person. NZART Council has the route through the NZART Administration Liaison Officer available for official negotiations on behalf of a member if the Council deems them necessary.

Difficult technical or social TVI/BCI interference problems should be notified to NZART promptly.

30. Conclusion

Remember that all BCI and TVI cases are capable of being technically cured. All you need is patience to test, diagnose the problem, and work out a cure. Many good textbook and magazine articles have been published and are available. The problem is not yours alone. Other radio amateurs are available to help you, many having experience with the problem. The MED RSM are there to help. TVI and BCI are accepted as a part of radio life and technical progress.

The neighbour also has a part to play. Cooperation and patience are necessary. Don't allow yourself to worry, and don't allow your neighbour to think that you should stop your operations.

Question File: 29. Interference & filtering: (3 questions)

1. Electromagnetic compatibility is:
 - a. two antennas facing each other
 - b. the ability of equipment to function satisfactorily in its own environment without introducing intolerable electromagnetic disturbances**
 - c. more than one relay solenoid operating simultaneously
 - d. the inability of equipment to function satisfactorily together and produce tolerable electromagnetic disturbances

=====
2. On an amateur receiver, unwanted signals are found at every 15.625 kHz. This is probably due to:
 - a. a low-frequency government station
 - b. a remote radar station
 - c. radiation from a nearby TV line oscillator**
 - d. none of these

=====
3. Narrow-band interference can be caused by:
 - a. transmitter harmonics**
 - b. a neon sign
 - c. a shaver motor
 - d. lightning flashes

=====
4. Which of the following is most likely to cause broad-band continuous interference:
 - a. an electric blanket switch
 - b. a refrigerator thermostat
 - c. a microwave transmitter
 - d. poor commutation in an electric motor**

=====
5. If broadband noise interference varies when it rains, the most likely cause could be from:
 - a. underground power cables
 - b. outside overhead power lines**
 - c. car ignitions
 - d. your antenna connection

=====
6. Before explaining to a neighbour that the reported interference is due to a lack of immunity in the neighbour's electronic equipment:
 - a. disconnect all your equipment from their power sources
 - b. write a letter to the MBIE
 - c. make sure that there is no interference on your own domestic equipment**
 - d. ignore all complaints and take no action

=====
7. A neighbour's stereo system is suffering RF break-through. One possible cure is to:
 - a. put a ferrite bead on the transmitter output lead
 - b. put a capacitor across the transmitter output

- c. use open-wire feeders to the antenna
 d. use screened wire for the loudspeaker leads
 =====
8. When living in a densely-populated area, it is wise to:
 a. always use maximum transmitter output power
 b. use the minimum transmitter output power necessary
 c. only transmit during popular television programme times
 d. point the beam at the maximum number of television antennas
 =====
9. When someone in the neighbourhood complains of TVI it is wise to:
 a. deny all responsibility
 b. immediately blame the other equipment
 c. inform all the other neighbours
 d. check your log to see if it coincides with your transmissions
 =====
10. Cross-modulation is usually caused by:
 a. rectification of strong signals in overloaded stages
 b. key-clicks generated at the transmitter
 c. improper filtering in the transmitter
 d. lack of receiver sensitivity and selectivity
 =====
11. When the signal from a transmitter overloads the audio stages of a broadcast receiver, the transmitted signal:
 a. can be heard irrespective of where the receiver is tuned
 b. appears only when a broadcast station is received
 c. is distorted on voice peaks
 d. appears on only one frequency
 =====
12. Cross-modulation of a broadcast receiver by a nearby transmitter would be noticed in the receiver as:
 a. a lack of signals being received
 b. the undesired signal in the background of the desired signal
 c. interference only when a broadcast signal is received
 d. distortion on transmitted voice peaks
 =====

13. Unwanted signals from a radio transmitter which cause harmful interference to other users are known as:
- rectified signals
 - re-radiation signals
 - reflected signals
 - harmonic and other spurious signals**
- =====
14. To reduce harmonic output from a transmitter, the following could be put in the transmission line as close to the transmitter as possible:
- wave trap
 - low-pass filter**
 - high-pass filter
 - band reject filter
- =====
15. To reduce energy from an HF transmitter getting into a television receiver, the following could be placed in the TV antenna lead as close to the TV as possible:
- active filter
 - low-pass filter
 - high-pass filter**
 - band reject filter
- =====
16. A low-pass filter used to eliminate the radiation of unwanted signals is connected to the:
- output of the balanced modulator
 - output of the amateur transmitter**
 - input of the stereo system
 - input of the mixer stage of your SSB transmitter
- =====
17. A band-pass filter will:
- pass frequencies each side of a band
 - attenuate low frequencies but not high frequencies
 - attenuate frequencies each side of a band**
 - attenuate high frequencies but not low frequencies
- =====
18. A band-stop filter will:
- pass frequencies each side of a band**
 - stop frequencies each side of a band
 - only allow one spot frequency through
 - pass frequencies below 100 MHz
- =====
19. A low-pass filter for a high frequency transmitter output would:
- attenuate frequencies above 30 MHz**
 - pass audio frequencies below 3 kHz
 - attenuate frequencies below 30 MHz
 - pass audio frequencies above 3 kHz
- =====

20. Installing a low-pass filter between the transmitter and transmission line will:
- permit higher frequency signals to pass to the antenna
 - ensure an SWR not exceeding 2:1
 - reduce the power output back to the legal maximum
 - permit lower frequency signals to pass to the antenna
- =====
21. A low-pass filter may be used in an amateur radio installation:
- to attenuate signals lower in frequency than the transmission
 - to attenuate signals higher in frequency than the transmission
 - to boost the output power of the lower frequency transmissions
 - to boost the power of higher frequency transmissions
- =====
22. Television interference caused by harmonics radiated from an amateur transmitter could be eliminated by fitting:
- a low-pass filter in the TV receiver antenna input
 - a high-pass filter in the transmitter output
 - a low-pass filter in the transmitter output
 - a band-pass filter to the speech amplifier
- =====
23. A high-pass filter can be used to:
- prevent interference to a telephone
 - prevent overmodulation in a transmitter
 - prevent interference to a TV receiver
 - pass a band of speech frequencies in a modulator
- =====
24. A high-pass RF filter would normally be fitted:
- between transmitter output and feedline
 - at the antenna terminals of a TV receiver
 - at the Morse key or keying relay in a transmitter
 - between microphone and speech amplifier
- =====
25. A high-pass filter attenuates:
- a band of frequencies in the VHF region
 - all except a band of VHF frequencies
 - high frequencies but not low frequencies
 - low frequencies but not high frequencies
- =====
26. An operational amplifier connected as a filter always utilises:
- positive feedback to reduce oscillation
 - negative feedback
 - random feedback
 - inductors and resistor circuits only
- =====

27. The voltage gain of an operational amplifier at low frequencies is:
- a. very high but purposely reduced using circuit components
 - b. very low but purposely increased using circuit components
 - c. less than one
 - d. undefined

=====

28. The input impedance of an operational amplifier is generally:
- a. very high
 - b. very low
 - c. capacitive
 - d. inductive

=====

29. An active audio low-pass filter could be constructed using:
- a. zener diodes and resistors
 - b. electrolytic capacitors and resistors
 - c. an operational amplifier, resistors and capacitors
 - d. a transformer and capacitors

=====

30. A filter used to attenuate a very narrow band of frequencies centred on 3.6 MHz would be called:
- a. a band-pass filter
 - b. a high-pass filter
 - c. a low-pass filter
 - d. a notch filter

=====

Section 30 Digital Communications

Contributed by Murray Greenman ZL1BPU

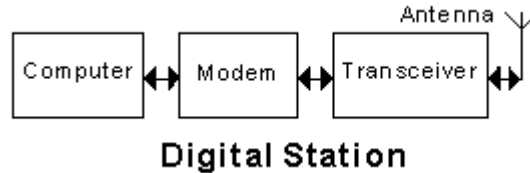

The original digital means of electrical communication was the Morse code. It is still in use today as a very successful method for transferring information by means other than voice. Today Morse has been joined by some other methods each with its own advantages and disadvantages.

RTTY, AMTOR, PACTOR, PSK31, Packet Radio and other modes have all been given a great boost with the arrival of the computer as a generally available appliance. In fact some of the new modes would be impossible without the computer and the PC sound card. The advent of satellites with store and forward facilities has also enhanced digital operations.

It is now possible to pass information to many parts of the world with a hand-held transceiver, modem, and computer, and also to have real-time conversations around the world using an HF radio and a computer. Each of these means of digital communication has its own protocol.

How Digital Modes are Generated

Two common digital coding schemes are used; the ITU-R ITA2 alphabet, (often misnamed the "Baudot code"), and the ITU-R ITA5 alphabet (or ASCII - American Standard Code for Information Interchange). ITA2 codes each character as a number between 0 and 31 to represent the various letters, digits and punctuation marks. To fit more than 32 different characters into the code, most numbers are used twice, and a special character (a "shift" character) is used to switch between the two meanings. The number can be represented by a 5-digit binary number (e.g. 14 = 01110 in binary). RTTY is one of the few systems that use the ITA2 alphabet today.

The ITA5 alphabet has 128 combinations, so a comprehensive alphabet, including lower and upper case letters, can be represented in seven binary bits. ITA-5 is used by PACTOR, packet radio and many other modes. Some digital modes (such as Morse!) use a scheme called a **Varicode** where the different characters are represented as numbers of different lengths. If the more frequently used characters are shorter, the transmission of plain text is therefore more efficient.

The numbers to be transmitted must then be modulated onto a radio signal in some way. There are three main properties of a radio signal; frequency, phase and strength (amplitude), so there are three common modulation methods, and some modes use a combination of two or more of these. Many modes are transmitted using Frequency Shift Keying (**FSK**). This in principle consists of switching between two adjacent frequencies which are used to designate the "0" or "1" data bits. The two tones must maintain a fixed frequency separation or shift and of course the radio frequencies must also be stable. The most common shifts used by amateurs on HF for FSK are

170 Hz and 200 Hz. Wider shifts are used on VHF where data rates and signal bandwidths can be higher. Other modes use more tones (Multiple Frequency Shift Keying, MFSK), or one of the other techniques, such as Phase Shift Keying (**PSK**), where the phase of the tone or carrier is varied, or Amplitude Shift Keying (**ASK**), where the signal strength is varied or even keyed on and off.

To send a character over the radio, one bit (binary digit), 0 or 1, is assigned to one of two states, or if there are more than two possible states (say if there are four tones or four PSK phases), then two or more bits at a time may define the state to transmit. The data changes the properties of the signal to be transmitted (i.e. modulates the signal), as each state is fed successively to the transmitter modulator, to define and transmit each symbol.

For the receiving end to be able to accurately decode the characters sent, the bits must be sent at a constant speed. The signalling speed of serial data transmissions on wires is measured in bits per second (bps), since the bits are always sent one at a time. However, the signalling speed on a radio link is not measured in bits, but in symbols per second (the unit of symbols/sec is the **baud**). The **symbol** is the basic modulated signalling entity on a radio link, and represents the state of each signalling interval. Each symbol may carry one or more (or even less) data bits, depending on the modulation technique. For RTTY, each symbol (a short duration of one tone or another) carries one data bit, so the speed in bps is the same as the baud rate.

The device that produces a modulated tone symbol for each data state, or creates a data state for each received tone symbol, is called a **modem** (a modulator /demodulator). The modem may be a special separate unit rather like a telephone modem, or sometimes the modulation is performed directly on a transmitter oscillator or a modulator, and a separate modem device may not be necessary except perhaps for receiving. Equally, the function of a modem now often takes place in a computer sound card, with the signals fed from it and to it by an SSB transceiver.

RTTY (Radio TeleTYpe) is one of the oldest of the machine-generated digital modes. It does not necessarily require a computer, as it is simple enough to be handled by a mechanical device similar to a typewriter - a teleprinter. RTTY, like most other digital modes, works by encoding characters into a digital alphabet.

Common speeds used by amateurs for RTTY are: 45.5, 50 and 75 baud, equivalent to 60 wpm, 66 wpm, and 100 wpm. (There are five letters and a space in the average "word").

AMTOR is a form of RTTY, now little used, that uses error checking to ensure that the data sent is received correctly. The message being sent is broken up into groups of three characters each. A special alphabet is used which has seven bits per character; every valid character always has a 4:3 ratio of 0s and 1s. This small packet is then transmitted through the modem to the radio. AMTOR always operates at 100 baud and uses 170 Hz shift FSK.

The system can operate in two modes, mode A and mode B. Mode A uses Automatic Repeat Request (**ARQ**) to ask the sending station to resend any packets that are not received properly (correct 4:3 ratio) once contact is established. Mode B sends the data twice, and checks the data but will not ask for a repeat. It is used for establishing contact (i.e. calling CQ) and for net and bulletin transmissions.

Packet Radio is an ARQ system like AMTOR, but with more powerful error checking and message handling abilities. Larger packets are used, and encoded in each packet are the sender and destination addresses, and a very efficient error detection scheme called a Cyclic Redundancy Check (CRC).

The Packet protocol allows a limited number of stations to carry on independent conversations on the same frequency without interference. The effective communication rate will be reduced if many stations are using the same frequency and excessive packet collisions occur.

Packets are assembled and prepared for transmission by a Terminal Node Controller (**TNC**), which manages the packet radio protocol and also contains a modem. The individual characters are usually in the ASCII alphabet, and a packet protocol called AX25 is usually used. The assembled packet is then passed to the modem and a radio in the same way as AMTOR or PACTOR.

Packet radio allows automated message forwarding throughout the world. Most activity is on VHF and higher bands where more stable propagation prevails and FM transmitters and receivers are used.

Large cities are centres of activity and cities are connected to each other by a series of relay stations. For longer distances the cities are connected by HF links (using PACTOR) or via internet or satellite gateways. Store-and-forward relaying is used. Most cities have a Bulletin Board System (**BBS**) for packet radio users. These can be used for the circulation of amateur radio information. They can be accessed by stations comprising a home computer, a simple modem and a VHF FM transceiver.

Another popular application of Packet Radio and AX25 is a telemetry technique sometimes called the Automatic Position Reporting System (APRS), although it is used for much more than reporting position. Stations with information to pass on send regular standard format messages in the manner of a beacon, which can be retransmitted by other stations. Applications of this type do not use bi-directional error correction, but do use automatic forwarding much the same as conventional packet systems.

PACTOR is derived from AMTOR. Like AMTOR it is a two-way error correcting system, but PACTOR dynamically adapts to conditions, switching from 100 baud to 200 baud. PACTOR can accept a series of imperfect data packets and reassemble them into the correct text. A recent version of PACTOR, called PACTOR II, uses the same protocol, but uses PSK modulation for even higher performance.

PSK31 is the most popular of the new digital modes. It is used like RTTY, for live keyboard-to-keyboard contacts. It uses differential binary PSK modulation at 31.25 baud. It is easy to tune in and to operate. The signal is very narrow (only 50Hz) and the performance very good, due to the high sensitivity and noise rejection of the PSK technique. PSK31 uses advanced digital signal processing (DSP), and can be run on many computer platforms, including Windows with a SoundBlaster type soundcard. The software is available free.

All you need to get going is a stable HF SSB Transceiver of conventional design, and a computer with a soundcard. You run two shielded audio cables between the rig and the sound card. The computer with its soundcard does the job of the modem. You can download FREE software from a web page. When all is set up, you have a live-keyboard system for chatting with other HF stations around the world. This is a really exciting mode. You can get further details about PSK31 from: <http://aintel.bi.ehu.es/psk31.html>

Other modes: There are numerous other digital modes in use, and more being introduced all the time. Many of these are designed for specific applications. For example, **MFSK16** was designed for very long distance low power real-time conversations, and also is most effective on lower bands with strong multi-path reception and burst noise. **CLOVER** is an ARQ mode designed for reliable long distance file transfer under poor conditions, while **MT63** was designed for net operation under severe interference. Some of these modes use interesting modulation methods such as single or multi-carrier Binary Phase Shift Keying **BPSK**, Quadrature Phase Shift Keying **QPSK**, or Orthogonal Frequency Division Multiplex **OFDM**. There are even special modes for moon-bounce, auroral signals, very weak LF communications and satellite operation. Many of these new modes also use a simple sound card modem and free software.

Don't overlook **Hellschreiber**. This is a mode with an interesting history. Hellschreiber is a method for sending text by radio or telephone line that involves dividing each text character into little pieces and sending them as dots. Hellschreiber was invented by the German inventor, Rudolf Hell who patented Hellschreiber in 1929.

The same SSB transceiver and computer set-up used for PSK31 can be used for Hellschreiber. Most Hellschreiber operation uses ASK modulation at 122.5 baud. You can check out the world of Hell on the web site at: <http://www.qsl.net/zl1bpu> and download the latest Hell software from there.

Hellschreiber is becoming popular with HF digital operators, as it provides very good performance with simple equipment and is easy to use. Its application is as a point-to-point mode for live contacts in a similar way to RTTY and PSK31. Modern variations such as **PSK-Hell** and **FM-Hell** provide even better performance with features to overcome specific ionospheric limitations of other digital modes.

Digital Modes and Propagation

While sensitivity and therefore rejection of **Broadband Noise** is an important property of digital modes, there are other specific ionospheric problems that affect digital modes more than is apparent on either Morse or voice modes. **Burst Noise** (electrical machinery, lightning) causes errors, interferes with synchronisation of data modes and impedes error correction systems, while **Carrier Interference**, (TV and mains harmonics, other radio transmissions) will obviously impair reception of most modes.

There are two other effects which are not so obvious. **Multi-path Reception**, where the signal arrives from different paths through the ionosphere with different time delays, can have a devastating effect on digital modes such as RTTY, that no increase in transmitter power will correct. The best solution to this problem is to use a mode with a very low baud rate, such as MFSK16 or MT63, to limit the timing errors. **Doppler Modulation**, caused mostly by fast moving air streams in the ionosphere or the movement of the apparent reflective height through changes in ion density, also has a serious effect, changing especially the phase and even the frequency of signals. This is best countered by using higher baud rates, or avoiding PSK modes. Doppler can be a big problem with long distance PSK31 operation.

Because the requirements for best performance conflict to some extent, and there is no one mode which will defeat all the problems, however in all cases the use of an effective error correction system (designed for the conditions) will provide significant improvements. The best solution is to choose an appropriate mode for the conditions prevailing at the time.

Automatic Packet Reporting System (APRS) is an amateur radio-based system for real time tactical digital communications of information of immediate value in the local area. In addition, all such data is ingested into the APRS Internet system (APRS-IS) and distributed globally for ubiquitous and immediate access. Along with messages, alerts, announcements and bulletins, the most visible aspect of APRS is its map display. Anyone may place any object or information on his or her map, and it is distributed to all maps of all users in the local RF network or monitoring the area via the Internet. Any station, radio or object that has an attached GPS is automatically tracked. Other prominent map features are weather stations, alerts and objects and other map-related amateur radio volunteer activities including Search and Rescue and signal direction finding.

APRS has been developed since the late 1980s by Bob Bruninga, callsign WB4APR, currently a senior research engineer at the United States Naval Academy. He still maintains the main APRS website. The acronym "APRS" was derived from his callsign

Question File: 30. Digital Systems: (1 question)

1. In the block diagram shown, the block designated "modem" is a:

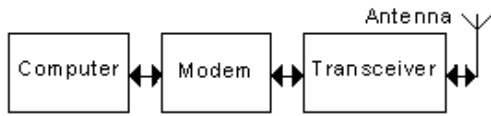

Digital Station

- a. modulator/demodulator
 b. modulation emphasis unit
 c. Morse demodulator
 d. MOSFET de-emphasis unit

2. In the block diagram shown, the "modem":

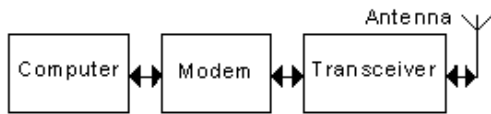

Digital Station

- a. monitors the demodulated signals
 b. de-emphasises the modulated data
 c. translates digital signals to and from audio signals
 d. determines the modulation protocol

3. The following can be adapted for use as a modem:

- a. an electronic keyer
 b. a spare transceiver
 c. a spare receiver
 d. a computer sound-card

4. The following are three digital communication modes:

- a. DSBSC, PACTOR, NBFM
 b. AGC, FSK, Clover
 c. PSK31, AFC, PSSN
 d. AMTOR, PACTOR, PSK31

5. In digital communications, FSK stands for:

- a. phase selection keying
 b. final section keying
 c. frequency shift keying
 d. final signal keying

6. In digital communications, BPSK stands for:

- a. binary phase shift keying
 b. baseband polarity shift keying
 c. band pass selective keying
 d. burst pulse signal keying

7. When your HF digital transmission is received with errors due to multi-path conditions, you should:

- a. increase transmitter power
 b. reduce transmitted baud rate

- c. reduce transmitter power
- d. change frequency slightly

=====

8. The letters BBS stand for:
- a. binary baud system
 - b. bulletin board system**
 - c. basic binary selector
 - d. broadcast band stopper

=====

9. APRS is an adaption of packet radio. APRS stands for
- a. Automatic Packet Reporting System**
 - b. Amateur Position Reporting System
 - c. Automatic Packet Relay System
 - d. Amateur Position Relay System

=====

10. The following communication mode is generally used for connecting to a VHF packet radio bulletin board:
- a. SSB
 - b. AM
 - c. FM**
 - d. DSB

=====

Creating sample NZART Exam Papers

Sample examination papers may be created by downloading the exam generator software from the NZART website at

<http://www.nzart.org.nz/assets/exam/NZART-Exam-generator17f.zip> .

Examination question answers are also available on the website so that sample exams can be checked.